

# Catálogo de Productos Truck



Arani Ltda



Lujos Arani Ltda



[www.arani.com.co](http://www.arani.com.co)





Linea de  
**Productos**

Catálogo de  
**Productos  
Truck**



**Iluminación**



**Seguridad  
vehicular**



**Accesorios**



**Espejos**



**Pitos**



**Plumillas**



**Cuidado y  
embellecimiento**



**Tapetes**



**Alarmas**



**Papel y  
cintas**



Arani Ltda



Lujos Arani Ltda



[www.arani.com.co](http://www.arani.com.co)





## **Iluminación**

**Bombillos Halógenas**

**Eléctricos Varios**

**Exploradoras**

**Kit LED**

**Lámparas**

**Licadoras**

**Ópticas**



Arani Ltda



Lujos Arani Ltda



[www.arani.com.co](http://www.arani.com.co)



Catálogo de **Productos Truck**

**Bombillos  
Halógenos**



MENÚ ▶



Composición de  
gas halógeno

Calota

Filamento para luz de  
cruce/luz baja

Lampara

Base

Terminal de acero inoxidable

Terminal de acero inoxidable





# Bombillos Halógenos

# Catálogo de Productos Truck

**BHP010**  
BOMB 1141 HELLA ESTANDAR 21W  
24V X10



**BHP015**  
BOMB H1 HELLA ESTANDAR 70W 24V X1



**BHP020**  
BOMB H3 HELLA ESTANDAR 70W 24V X1



**BHP025**  
BOMB H4 HELLA ESTANDAR 75/70W 24V X1



**BHP027**  
BOMB H4 HELLA ESTANDAR 100/90W 24V X1



**BHP030**  
BOMB H7 HELLA ESTANDAR 70W 24V X1



**BMP009**  
BOMB H4 OSRAM ESTANDAR 10748047 75/70W  
24V X1





**BIA001**  
BOMB 880 ESTANDAR 27W 12V X1



**BIA011**  
BOMB H1 ESTANDAR 55W 12V X1



**BIA013**  
BOMB H3 ESTANDAR 55W 12V X1



**BIA017**  
BOMB H4 ESTANDAR 60/55W 12V X1



**BIA019**  
BOMB H7 ESTANDAR 55W 12V X1



**BIA020**  
BOMB H8 ESTANDAR 35W 12V X1



**BIA021**  
BOMB H11 ESTANDAR 55W 12V X1



**BIA023**  
BOMB H13 ESTANDAR 60/55W 12V X1





**BIF001**  
BOMB 880 SUPER WHITE 27W 12V X1

**880** 27W



**BIF003**  
BOMB H1 SUPER WHITE 55W 12V X1

10 Und.  
**H1** 55W



**BIF004**  
BOMB H3 SUPER WHITE 55W 12V X1

10 Und.  
**H3** 55W



**BIF009**  
BOMB H4 SUPER WHITE 60/55W 12V X1

**H4** 60/55W



**BIF013**  
BOMB H7 SUPER WHITE 55W 12V X1

**H7** 55W



**BIF020**  
BOMB H8 SUPER WHITE 35W 12V X1

**H8** 35W



**BIF021**  
BOMB H11 SUPER WHITE 55W 12V X1

**H11** 55W





# Bombillos Halógenos

# Catálogo de Productos Truck

**BIM010**  
BOMB 1034 ESTANDAR 21/5W 12V X10



10 Und.  
**1034** 21/5W

**BIM014**  
BOMB 921 ESTANDAR 18W 12V X10



10 Und.  
**921** 18W

**BIM015**  
BOMB 1141 ESTANDAR 21W 12V X10



10 Und.  
**1141** 21W

**BIM020**  
BOMB 1141 AMBAR 21W 12V X10



10 Und.  
**1141** 21W

**BIM025**  
BOMB 158 ESTANDAR 5W 12V X10



10 Und.  
**158** 5W

**BIM005**  
BOMB T5 ESTANDAR 2W 12V X10



10 Und.  
**T5** 2W



Catálogo de **Productos Truck**

**Eléctricos**   
**Varios**

MENÚ ►

**ELF016**  
RELAY HELLA 4 PATAS  
30 AMP 12V X1



**ELF021**  
RELAY HELLA 5 PATAS  
20/40 AMP 12V X1



**ELF036**  
RELAY HELLA 4 PATAS  
30 AMP 24V X1



**ELF040**  
RELAY HELLA 5 PATAS  
10/20 AMP 24V X1



**ELV003**  
BALASTO FACET  
LED INTERM 12-24V



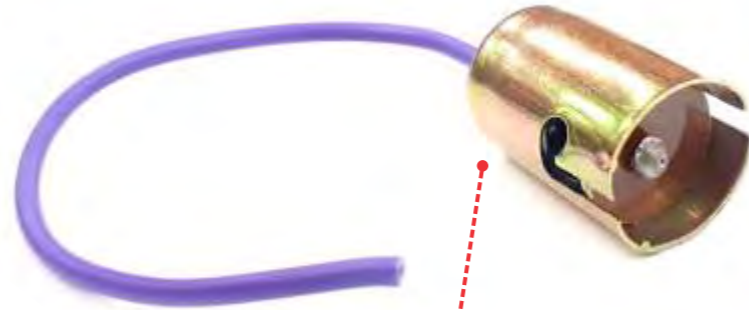

**ELV818**  
SOCKET BOMB  
1141 LISO SKL1 X-

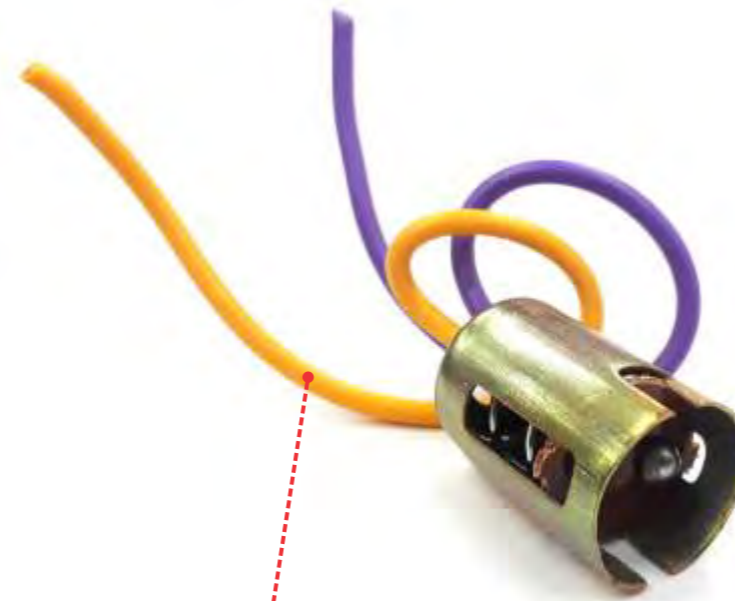

**ELV822**  
SOCKET BOMB  
1034 LISO SKL2 X10

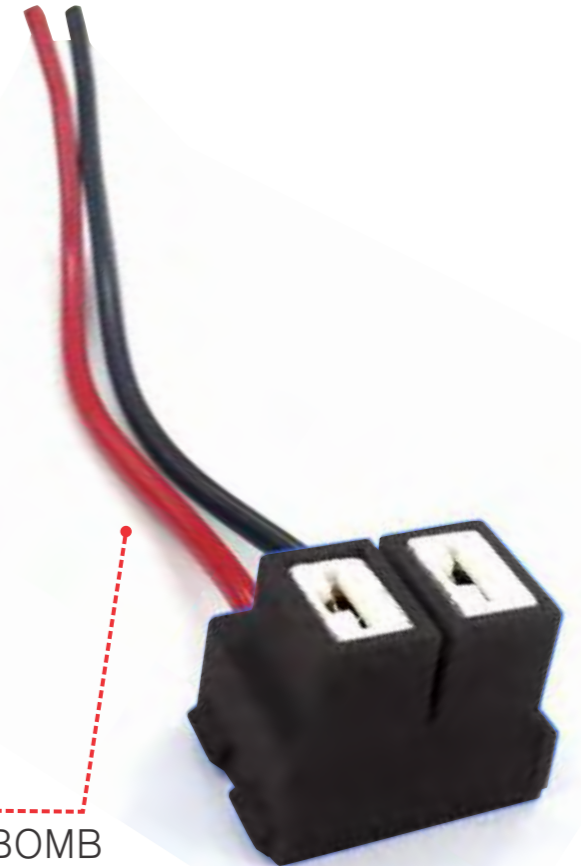

**ELV826**  
SOCKET BOMB  
H7 LOZA SKH7L X10



**ELV802**  
CONECT EXP  
H11 DJ43 X1



**ELV834**  
SOCKET RELAY  
LOZA CABLE 16  
CENTELSA X10



**ELV842**  
SOKET UNIDAD  
LOZA CABLE  
16 CENTELSA X10



**ELV852**  
PORTAFUSIBLE  
ELECTRO ARMABLE  
CABLE 16 CENTELSA X10

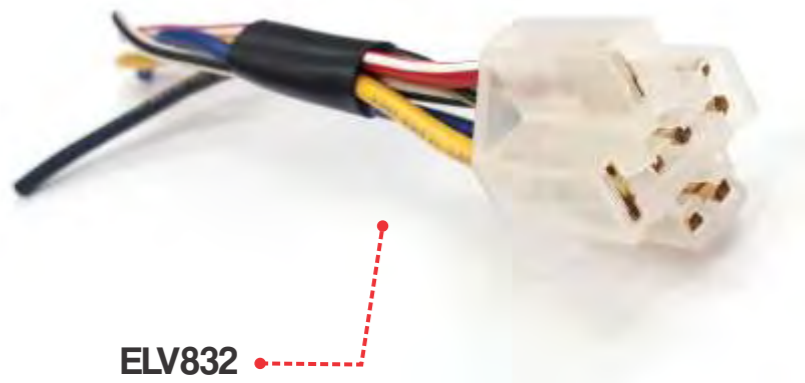

**ELV832**  
SOCKET RELAY  
CABLE 16 CENTELSA X10



**ELV840**  
SOCKET UNIDAD  
CURVO CABLE 16  
CENTELSA X10



**ELV876**

SWITCH BLOQUEO  
UNIV 3 PINES NEGRO  
SW37 X10

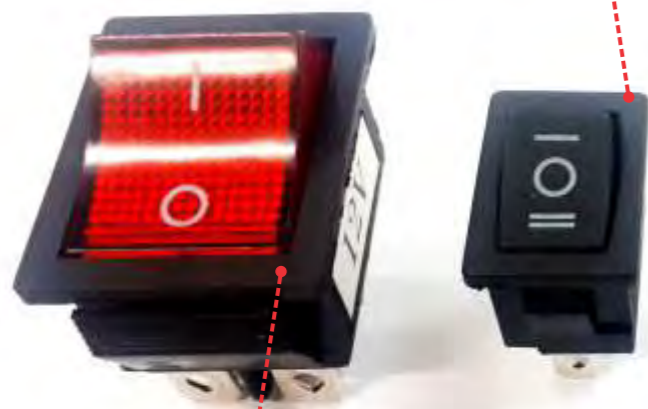

**ELV864**

SWITCH BASE  
REDONDA  
ROJO SW19 X10



**ELV872**

SWITCH ON-OFF  
2 PINES NEGRO  
REVERSIBLE SW25 X10



**ELV860**

SWITCH BALANCIN  
GRANDE 4 PINES SW1 X10



**ELV880**

SWITCH PULSADOR  
BASE REDONDA  
ROJO SW18 X10



**ELV868**

SWITCH ON-OFF 2 PINES  
NEGRO SW26 X10



## MODULOS LED SMD 24Voltios

**ELV472**  
MODULO LED AMARILLO SMD 24V X10



**ELV474**  
MODULO LED AZUL SMD 24V X10



**ELV476**  
MODULO LED BLANCO SMD 24V X10



**ELV480**  
MODULO LED PURPURA SMD 24V X10



Adhesivo 3M

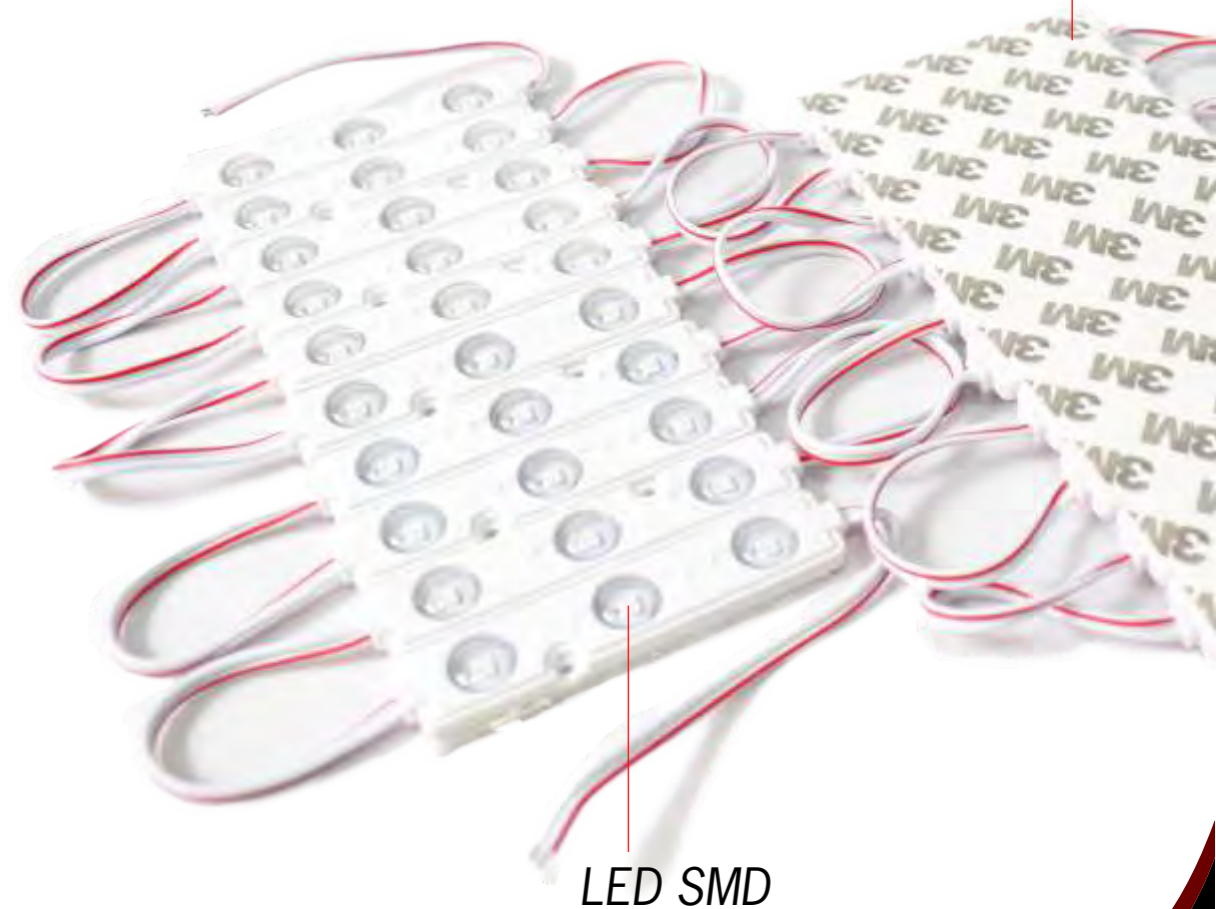



## MODULOS LED SMD 24Voltios

**ELV483**  
MODULO LED ROJO SMD 24V X10



**ELV484**  
MODULO LED VERDE SMD 24V X10



Adhesivo 3M

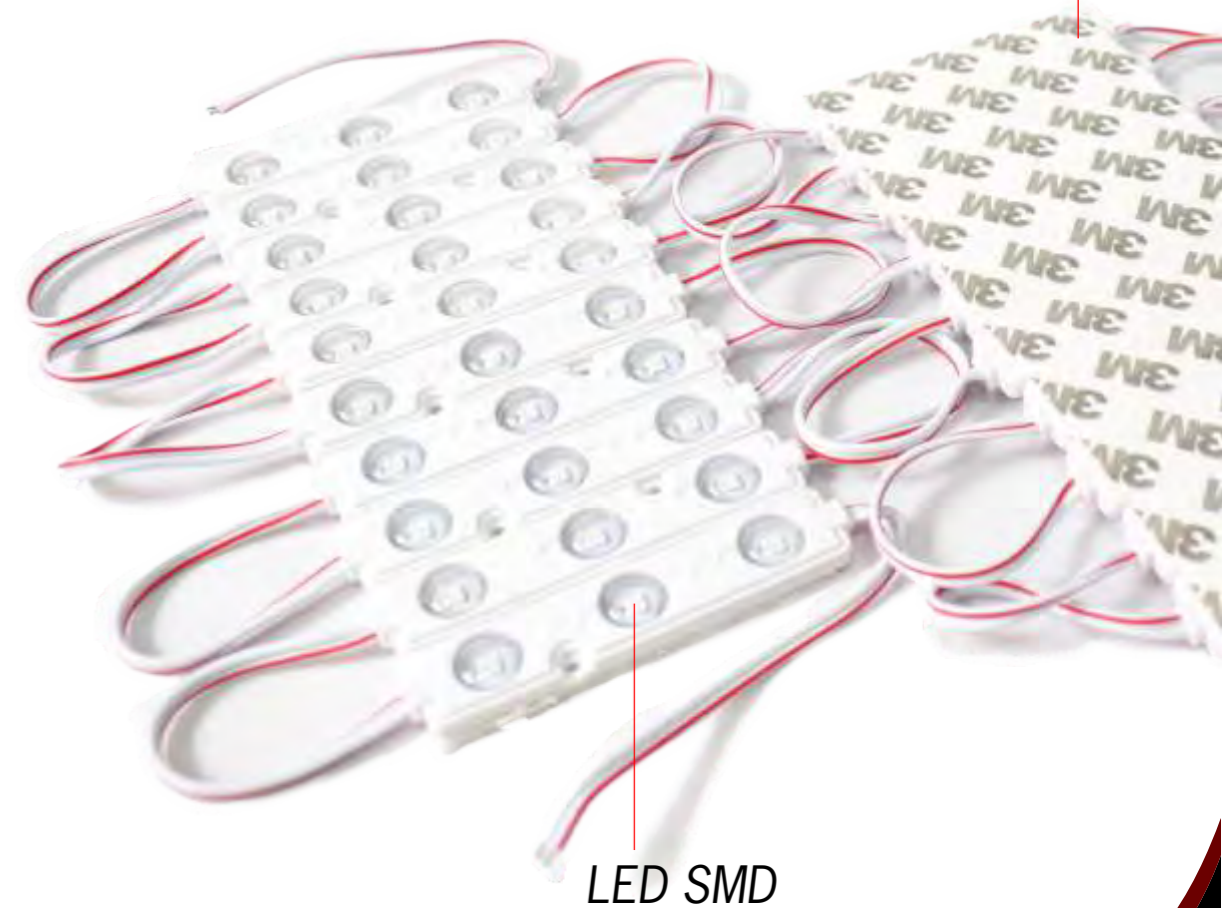



**CINTA LED 5050 FLEXIBLE INTERIOR  
24 Voltios**

**ELV990**  
CINTA LED 5050 FLEX  
INT AMA 1CMX5M 24V



**ELV992**  
CINTA LED 5050 FLEX  
INT AZU 1CMX5M 24V



**ELV994**  
CINTA LED 5050 FLEX  
INT BLA 1CMX5M 24V





**CINTA LED 5050 FLEXIBLE INTERIOR  
24 Voltios**

**ELV995**  
CINTA LED 5050 FLEX  
INT LIL 1CMX5M 24V



**ELV996**  
CINTA LED 5050 FLEX  
INT ROJ 1CMX5M 24V



**ELV997**  
CINTA LED 5050 FLEX  
INT VER 1CMX5M 24V

## Ultraviolet

Desinfectante de espacios.

- ✓ Potente desinfectante y esterilizante de espacios con banda de ondas de alta eficiencia

UV-C 275

- ✓ Este nivel de ondas logra destruir el ADN y ARN de virus y bacterias, utilizado en equipos de desinfección de alta calidad.



- ✓ Desinfecta y esteriliza cualquier superficie en un rango de 4 m<sup>3</sup> cúbicos, destruye el ADN y ARN de patógenos matando virus y bacterias evitando así su reproducción.



Batería recargable, cárguelo y use libre de conexiones continuamente hasta 150 minutos.



### Indicador Led de tiempo



10 min. Indicador Azul  
Mejora el ambiente de bacterias 95%.



20 min. Indicador Verde  
Elimina la gran mayoría de los virus 97%



30 min. Indicador Rojo  
Elimina el 99.9% de los virus.

Sonido de finalización de desinfección.

ELV952  
DISPOSITIVO DE DESINFECCIÓN  
LUZ UV PARA ESPACIOS 8V  
10cm X10cm X5.5cm

Puede usar para desinfectar:  
Interior del vehículo,  
closets, celulares, billeteras,  
llaves, tapa bocas, cocina,  
utensilios de cocina,  
interior de nevera, habitaciones,  
artículos para bebé, frutas,  
accesorios de oficina,  
computadores etc.

Efectivo contra ácaros, **no genera residuos** en la desinfección,  
evitar el contacto directo con los ojos

Superficies, espacios y objetos libres de virus tales como: el nuevo **coronavirus**, Sars, bacterias, hongos, gérmenes (Trichophyton, cándida, Scopulariopsis y patógenos).





# Eléctricos varios



## Ultraviolet

Desinfectante de espacios.

ELV952  
DISPOSITIVO DE DESINFECCIÓN  
LUZ UV PARA ESPACIOS 8V  
10cm X10cm X5.5cm

Puede eliminar el nuevo **coronavirus**  
de superficies, espacios y objetos.



20 a 30  
MINUTOS  
en el vehículo

30  
MINUTOS  
en la habitación

20  
SEGUNDOS  
Botones de ascensores

30  
SEGUNDOS  
en teléfonos móviles



# Eléctricos varios

## Ultraviolet

Dispositivo de desinfección multiusos.

✓ Desinfecta y esteriliza todo tipo de objetos mediante luz ultra violeta.

✓ Banda de ondas de alta eficiencia

UV-C 253,7

✓ A partir de este nivel de ondas se logra destruir el ADN y ARN de virus y bacterias utilizado en equipos de desinfección de alta calidad.

✓ Elimina el 99.9% de los virus presentes en tan solo 5 minutos, función de aromaterapia, además de desinfectar deja un agradable aroma a los objetos.

✓ Fácil de utilizar, conexión

✓ Evite el contacto directo con los ojos, no abrir la compuerta antes de terminar el proceso de desinfección o aromaterapia.



ELV950  
DISPOSITIVO DE DESINFECCIÓN LUZ UV  
MULTIUSOS 5V  
21.8 cm X 12.2cm X 5.5cm X1





Catálogo de **Productos Truck**

**Exploradoras**   
**LED**

**MENÚ** 

## EXC100

EXPL LED 24W 12/24V 9 LEDS EXP  
NEG 128X110X45MM X1



## EXC115

EXPL 20W 12/24V 4 LED EXP 72X72X40 X1



## EXC117

EXP 27W 9/32V 9 LED EXP P.REVER  
128X108X47MM X1



## EXC118

EXP 20W 12/24V 2 LED EXP  
LP 83X78X82 X1







**EXC120**  
EXPL 27W 12/24V 9 LED EXP LT AMA  
128X105X45MM X1



**EXC150**  
EXPL 27W 12/24V 9 LED 0.ANG AZU  
128X105X45MM X1



9 LED  
27w  
2050 lumens



12-24 V

← Color de luz real

**EXC155**  
EXPL 27W 12/24V 9 LED 0.ANG BLA  
128X105X45MM X1



9 LED  
27w  
2050 lumens



12-24 V

← Color de luz real

**EXC165**  
EXPL 27W 12/24V 9 LED 0.ANG ROJ  
128X105X45MM X1



9 LED  
27w  
2050 lumens



12-24 V

← Color de luz real

# Exploradoras LED

# Catálogo de Productos Truck

## EXC172

EXP 20W 12/24V 4 LED EXP LP 0.ANG AZU  
70X60X50 X1



LED  
CREE



## EXC176

EXP 20W 12/24V 4 LED EXP LP 0.ANG ROJ  
70X60X50 X1



LED  
CREE



## EXC174

EXP 20W 12/24V 4 LED EXP LP 0.ANG BLA  
70X60X50 X1 0.ANG BLA



LED  
CREE



**Producto**  
**¡Nuevo!**





# Exploradoras LED

# Catálogo de Productos Truck

## EXC202

EXPL 49W 12/24V 54 LED CH/EX DRL AMB  
128X107X45 X1



LUZ DRL  
AMBAR

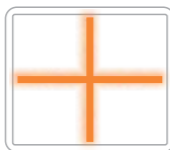

LED  
CREE

LED  
49W



12/24  
MULTIVOLTAJE



## EXC205

EXPL 49W 12/24V 54 LED CH/EX DRL AZU  
128X107X45 X1



LUZ DRL  
AZUL

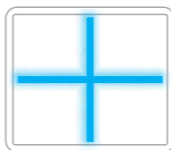

LED  
CREE

LED  
49W



12/24  
MULTIVOLTAJE



## EXC210

EXPL 49W 12/24V 54 LED CH/EX DRL BLA  
128X107X45 X1



LUZ DRL  
BLANCO

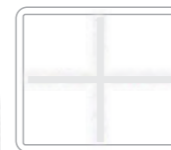

LED  
CREE

LED  
49W



12/24  
MULTIVOLTAJE



## EXC220

EXPL 49W 12/24V 54 LED CH/EX DRL ROJ  
128X107X45 X1



LUZ DRL  
ROJO



LED  
CREE

LED  
49W



12/24  
MULTIVOLTAJE



## EXC505

EXPL LED HELLA 12W 12/24V 4 LED  
EXP 8X8X8 X1



## EXC510

EXPL LED HELLA 15W 12/24 9LED EXP NEG  
10X10X4CM X1



## EXD100

EXPL LED 12W 12/24V 4 LEDS CHO NEG  
66X66X65MM X1



## EXD105

EXPL LED 24W 12/24V 9 LEDS EXP NEG  
128X110X45MM X1





# Exploradoras LED

# Catálogo de Productos Truck

**EXD118**  
EXP 30W 12/24V 6 LED EXP LP 115X115X55 X1



LED  
CREE

- LED 30W
- 12/24 MULTIVOLTAJE
- 6 LEDS EXPANSA
- LENTE PRISMA
- 2200 LUMENS REALES



**EXD120**  
EXPL 27W 12/24V 9 LED EXP LT AMA 128X110X45MM X1



**EXD150**  
EXPL 27W 12/24V 9 LED O.ANG AZU 128X110X45MM X1



- 9 LED 27w 2050 lumens
- 12-24 V
- Color de luz real

**EXD155**  
EXPL 27W 12/24V 9 LED O.ANG BLA 128X110X45MM X1



- 9 LED 27w 2050 lumens
- 12-24 V
- Color de luz real

## EXD165

EXPL 27W 12/24V 9 LED O.ANG ROJ  
128X110X45MM X1



## EXD172

EXPL 12W 12/24V 4 LED O.ANG BLA  
CHO 90X90X50 X1



## EXD174

EXPL 12W 12/24V 4 LED O.ANG AZU  
CHO 90X90X50 X1



## EXD176

EXPL 12W 12/24V 4 LED O.ANG ROJ  
CHO 90X90X50 X1





# Exploradoras LED

# Catálogo de Productos Truck

**EXD182**  
EXP 20W 12/24V 4 LED EXP LP 0.ANG AZU  
70X70X50 X1



LED  
CREE

**EXD184**  
EXP 20W 12/24V 4 LED EXP LP 0.ANG BLA.  
70X70X50 X1



LED  
CREE

**EXD186**  
EXP 20W 12/24V 4 LED EXP LP 0.ANG ROJ  
70X70X50 X1



LED  
CREE

**Producto**  
**¡Nuevo!**



# Exploradoras LED

# Catálogo de Productos Truck

**EXD204**  
EXPL TRANSFOR U7 10W 12/24V 0/ANGEL  
AZUL X1



Color de luz real

**EXD206**  
EXPL TRANSFOR U7 10W 12/24V 0/ANGEL  
Blanco X1





# Exploradoras LED

# Catálogo de Productos Truck

**EXD252**  
EXPL 29W 12/24V 39 LED CH/EX DRL AMB  
128X112X45 X1



**LUZ DRL  
AMBAR**



**LED  
CREE**

**LED  
29W**



**12/24  
MULTIVOLTAJE**



**39 LEDS  
EXPANSIVA Y ENFOQUE**



**4200  
LUMENS REALES**

**EXD255**  
EXPL 29W 12/24V 39 LED CH/EX DRL AZU  
128X112X45 X1



**LUZ DRL  
AZUL**



**LED  
CREE**

**LED  
29W**



**12/24  
MULTIVOLTAJE**



**39 LEDS  
EXPANSIVA Y ENFOQUE**



**4200  
LUMENS REALES**

**EXD260**  
EXPL 29W 12/24V 39 LED CH/EX DRL BLA  
128X112X45 X1



**LUZ DRL  
BLANCO**



**LED  
CREE**

**LED  
29W**



**12/24  
MULTIVOLTAJE**



**39 LEDS  
EXPANSIVA Y ENFOQUE**



**4200  
LUMENS REALES**

**EXD270**  
EXPL 29W 12/24V 39 LED CH/EX DRL ROJ  
128X112X45 X1



**LUZ DRL  
ROJO**



**LED  
CREE**

**LED  
29W**



**12/24  
MULTIVOLTAJE**



**39 LEDS  
EXPANSIVA Y ENFOQUE**



**4200  
LUMENS REALES**



**EXD505**  
EXPL LED HELLA 18W 12/24V 5 LED CHO  
9X9X6 X1



**EXD515**  
EXPL LED HELLA 18W 12/24V 5 LED CHO  
EMP 12X12X6 X1



**EXD520**  
EXPL LED HELLA 15W 12/24 9 LED EXP  
NEG 4" X1



**Ex0124**  
EXP 20W 12/24V 2 LED CHO LL 83X78X82 X1





# Exploradoras LED

# Catálogo de Productos Truck

**EXR100**  
EXPL LED 18W 12/24V 6 LEDS EXP NEG  
160X63X45MM X1



**EXR110**  
EXPL 18W 12/24V 6 LED EXP LT AMA  
160X63X45MM X1



**EXR112**  
EXPL 36W 12/24V 12 LED EXP LT AMA  
100X80X60 X1



- LED 36W
- 3000 k
- 12/24 MULTIVOLTAJE
- 12 LEDS EXPANSIVA
- 1020 LUMENS REALES

**EXR114**  
EXPL 60W 12/24V 20 LED EXP LT AMA  
100X80X60 X1



- LED 60W
- 3000 k
- 12/24 MULTIVOLTAJE
- 20 LEDS EXPANSIVA
- 1700 LUMENS REALES



# Exploradoras LED

# Catálogo de Productos Truck

**EXR115**  
EXPL 72W 12/24V 24 LED EXP LT AMA  
135X80X60 X1



**EXR118**  
EXPL 120W 12/24V 40 LED EXP LT AMA  
165X80X60 X1



**EXR120**  
EXPL 18W 12/24V 6 LED CHO 100X80X60 X1



**EXR125**  
EXPL 36W 12/24V 12 LED CHO 162X80X60 X1





## EXR129

EXPL 60W 12/24V 12 LED CHO FLASH AMB  
95X70X80 X1



## EXR130

EXPL 60W 12/24V 12 LED CHO FLASH AZU  
95X70X80 X1



## EXR134

EXPL 60W 12/24V 12 LED CHO FLASH BLA  
95X70X80 X1



## EXR138

EXPL 60W 12/24V 12 LED CHO FLASH ROJ  
95X70X80 X1



**EXR140**  
EXPL 36W 12/24V 12 LED EXP 100X80X60 X1



**EXR142**  
EXPL 72W 12/24V 24 LED EXP 135X80X60 X1



**EXR143**  
EXPL 72W 12/24V 24 LED EXP LT NAR 135X80X60 X1



**EXR144**  
EXPL 84W 12/24V 28 LED EXP 130X80X60 X1





# Exploradoras LED

# Catálogo de Productos Truck

## EXR146

EXPL 240W 12/24V 80 LED EXP  
350X80X60 X1



## EXR148

EXPL 180W 12/24V 60 LED EXP 235X80X60 X1



## EXR152

EXPL 18W 12/24V 6 LED O.ANG BLA CHO  
110X75X55 X1



LED  
EPISTAR

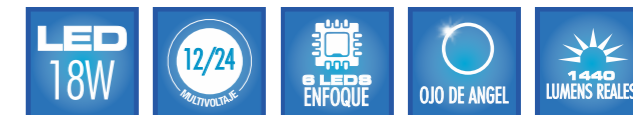

# Exploradoras LED

# Catálogo de Productos Truck

## EXR154

EXPL 18W 12/24V 6 LED O.ANG AZU CHO  
110X75X55 X1



LED  
EPISTAR



## EXR158

EXPL 18W 12/24V 6 LED O.ANG ROJ CHO  
110X75X55 X1



## EXR170

EXPL 16W 12/24V 16 LED CH/EX FED MF  
160X63X45 X1



LED  
SAMSUNG



## EXR172

EXP 16W 12/24V 16 LED CH/EX BL/AM MF  
160X63X45 X1



LED  
SAMSUNG





# Exploradoras LED

**EXR174**  
EXPL 20W 12/24V 20 LED CH/EX FED  
MF 95X70X80 X1



LED  
SAMSUNG



MULTI-FUNCIÓN FLUO-FLASHEO

**EXR186**  
EXPL 36W 12/24V 12 LED EXP BLA/AMA  
MF 100X80X60 X1



LED  
SAMSUNG



MULTI-FUNCIÓN FLUO-FLASHEO

**EXR190**  
EXPL 72W 12/24V 24 LED EXP LT NAR  
135X80X60 X1



LED  
SAMSUNG



MULTI-FUNCIÓN FLUO-FLASHEO

**EXR505**  
EXPL LED HELLA 18W 12/24V 6 LED EXP  
16X6X5 X1



# Catálogo de **Productos Truck**

**Kit  
LED**



**MENÚ** ▶



## KIT LED HEADLIGHT

# D7

6000  
LUMENS  
X 2

12 - 24 V.

Mejor Calidad / Mejor iluminación / Mejor Calidad / Mejor iluminación

**Nueva  
Generación**



**Potente Chip LED Csp  
20% + Brillo y potencia**

**Eficiente disipador en  
aluminio de aviación**

**Amplio espacio de  
ventilación**

- **BOD230**  
KIT LED D7 **880** 12000 LM  
8000K 30W DC 12V-24V X1
- **BOD232**  
KIT LED D7 **9005** 12000 LM  
8000K 30W DC 12V-24V X1
- **BOD233**  
KIT LED D7 **9006** 12000 LM  
8000K 30W DC 12V-24V X1
- **BOD235**  
KIT LED D7 **H1** 12000 LM  
8000K 30W DC 12V-24V X1
- **BOD236**  
KIT LED D7 **H3** 12000 LM  
8000K 30W DC 12V-24V X1
- **BOD237**  
KIT LED D7 **H4 H/L** 12000 LM  
8000K 30W DC 12V24V X1
- **BOD238**  
KIT LED D7 **H7** 12000 LM  
8000K 30W DC 12V-24V X1
- **BOD239**  
KIT LED D7 **H11** 12000 LM  
8000K 30W DC 12V-24V X1
- **BOD242**  
KIT LED D7 **H8** 12000 LM  
8000K 30W DC 12V-24V X1
- **BOD245**  
KIT LED D7 **H13** 12000 LM  
8000K 30W DC 12V-24V X1
- **BOD248**  
KIT LED D7 **H16** 12000 LM  
8000K 30W DC 12V-24V X1



## LUZ LED



4000  
lumen  
X2

Producto diseñado simulando el tamaño y la posición exacta del filamento de un bombillo halógeno tradicional, creando un tipo de iluminación que aprovecha al máximo el diseño de la óptica original del vehículo, generando mayor intensidad y distancia de la luz.

REFERENCIA DE PRODUCTO

- BOY220** LED 880
- BOY222** LED 9005
- BOY223** LED 9006
- BOY225** LED H1
- BOY226** LED H3
- BOY228** LED H7
- BOY229** LED H11

## 3 colores en un solo bombillo

LED

Luz de LED 2 Und. 150% más luz que una lámpara halógena

**E-xtremely Bright LED**

25

Wattios

9-32

Voltaje

3000K 4300K 8000K



Lámparas halógenas estándar

Lámparas LED

Este producto

Otro producto



## KIT LED HEADLIGHT

# G80

6000 LUMENS X 2  
12 - 24V.

Mejor Calidad / Mejor

iluminación / Mejor Calidad / Mejor iluminación / Mejor Calidad / Mejor iluminación

Mejor Calidad / Mejor iluminación

**Nueva Generación**

**Nueva tecnología LED Cree 2.0 30% +Brillo**

**Eficiente disipador en aluminio de aviación**

- **BOY620**  
KIT LED G8 **880** 12000 LM  
8000K 25W DC 12V-24V X1
- **BOY622**  
KIT LED G8 **9005** 12000 LM  
8000K 25W DC 12V-24V X1
- **BOY623**  
KIT LED G8 **9006** 12000 LM  
8000K 25W DC 12V-24V X1
- **BOY625**  
KIT LED G8 **H1** 12000 LM  
8000K 25W DC 12V-24V X1
- **BOY626**  
KIT LED G8 **H3** 12000 LM  
8000K 25W DC 12V-24V X1
- **BOY627**  
KIT LED G8 **H4** H/L 12000 LM  
8000K 25W DC 12V-24V X1
- **BOY628**  
KIT LED G8 **H7** 12000 LM  
8000K 25W DC 12V-24V X1
- **BOY629**  
KIT LED G8 **H11** 12000 LM  
8000K 25W DC 12V-24V X1
- **BOY632**  
KIT LED G8 **H8** 12000 LM  
8000K 25W DC 12V-24V X1
- **BOY635**  
KIT LED G8 **H13** HL 12000 LM  
8000K 25W DC 12V-24V X1
- **BOY638**  
KIT LED G8 **H16** 12000 LM  
8000K 25W DC 12V-24V X1



**300% +**  
Brillo que un bombillo Halógeno

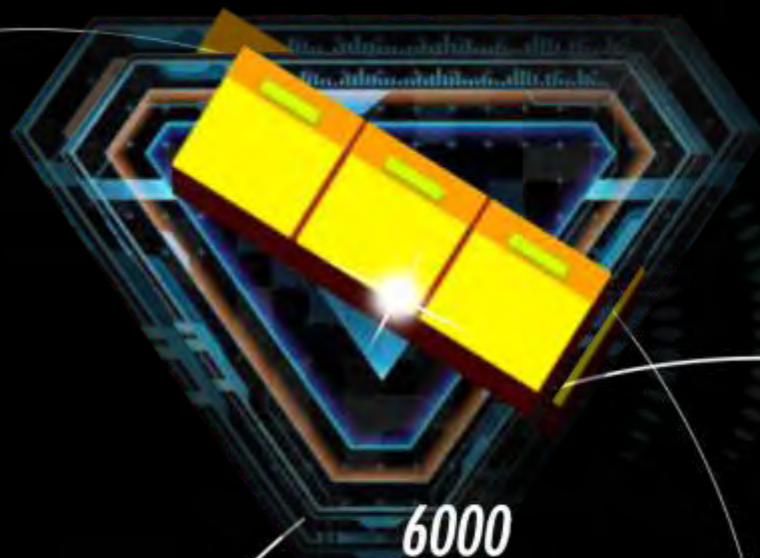

**6000**  
Lumens por bombillo 8000k



**Chip de luz Zes Lumileds**

## M3 KIT LED

*Luz alineada en la misma posición de un bombillo halogeno convencional.*

**MAYOR ENFOQUE Y PROFUNDIDAD**

**Dual canal de refrigeración  
por cooler a 13.000rpm y  
aluminio de aviación 6063**







**Vida útil  
30.000 horas**

**Sistema inteligente  
de control  
de temperatura**

**Multivoltaje  
9 - 32 voltios**

**No tiene polaridad**

**Resistente al  
Agua Ip65**

**Conexión Plug and play 3.0  
(Sistema diseñado para ser compatible con el 98% de los vehículos)**

## M3 KIT LED

Luz alineada en la misma posición de un bombillo halogeno convencional.

**MAYOR ENFOQUE Y PROFUNDIDAD**

## M3 KIT LED

Luz alineada en la misma posición de un bombillo halogeno convencional.

MAYOR ENFOQUE Y PROFUNDIDAD



**BOZ225**  
KIT LED M3 H1 6000 LUM 8000K 55W  
DC 12V-24V X1



**BOZ226**  
KIT LED M3 H3 6000 LUM 8000K 55W  
DC 12V-24V X1



**BOZ227**  
KIT LED M3 H4 H/L 6000 LUM 8000K 55W  
DC 12V-24V X1



**BOZ228**  
KIT LED M3 H7 6000 LUM 8000K 55W  
DC 12V-24V X1



## M3 KIT LED

Luz alineada en la misma posición de un bombillo halogeno convencional.

MAYOR ENFOQUE Y PROFUNDIDAD



**BOZ229**  
KIT LED M3 H11 6000 LUM 8000K 55W  
DC 12V-24V X1



**BOZ222**  
KIT LED M3 9005 6000 LUM 8000K 55W  
DC 12V-24V X1



**BOZ223**  
KIT LED M3 9006 6000 LUM 8000K 55W  
DC 12V-24V X1



**BOZ232**  
KIT LED M3 H8 6000 LUM 8000K 55W  
DC 12V-24V X1

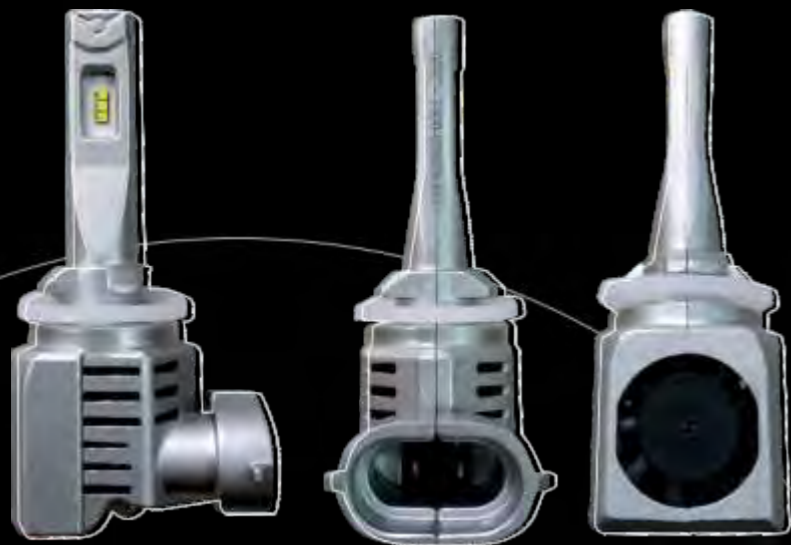

**BOZ220**  
KIT LED M3 880 6000 LUM 8000K 55W  
DC 12V-24V X1

## M3 KIT LED

Luz alineada en la misma posición de un bombillo halogeno convencional.

MAYOR ENFOQUE Y PROFUNDIDAD



**BOZ238**  
KIT LED M3 H16 6000 LUM 8000K 55W  
DC 12V-24V X1



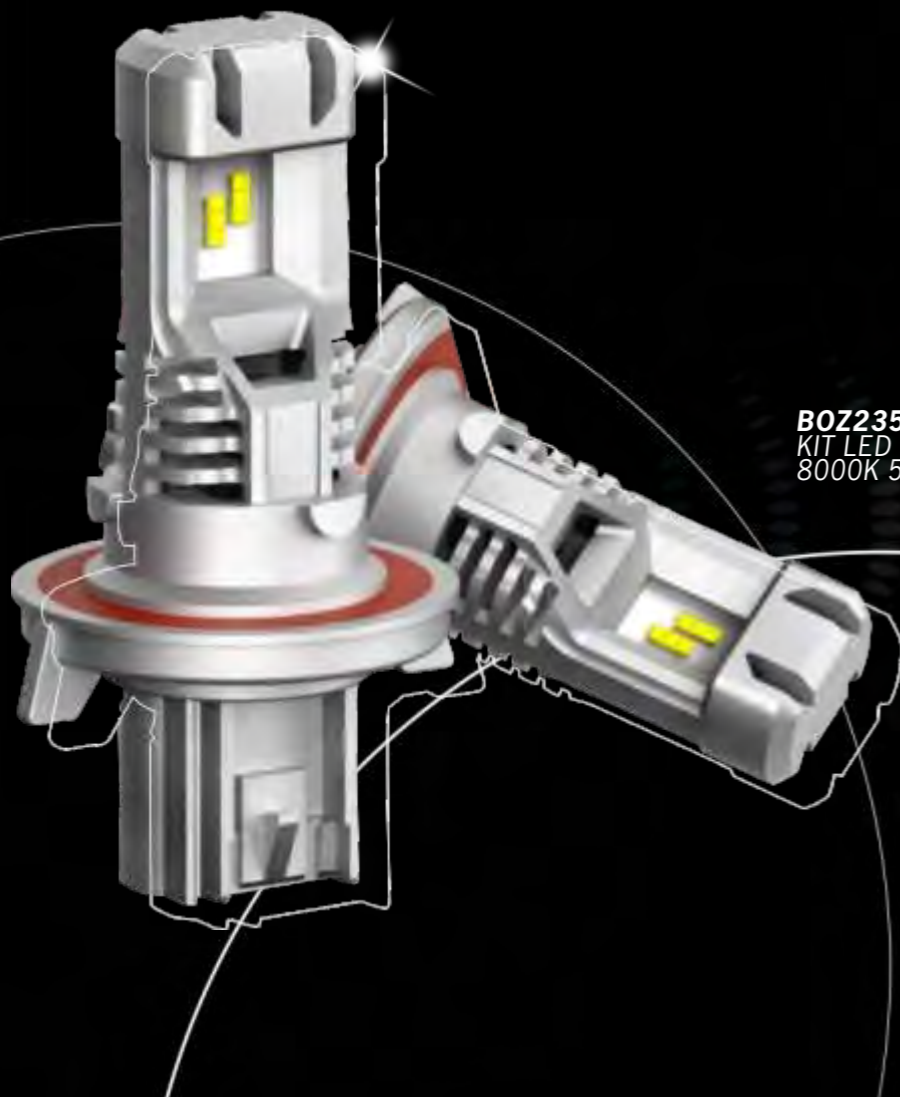

**BOZ235**  
KIT LED M3 H13 H/L 6000LUM  
8000K 55W DC 12V-24V X1

## M3 KIT LED

*Luz alineada en la misma posición de un bombillo halogeno convencional.*

**MAYOR ENFOQUE Y PROFUNDIDAD**

Catálogo de **Productos Truck**

**Licadoras y  
Lámparas**



**MENÚ ▶**



**LICUADORA VASO TRANSPARENTE 2 STROBER LED**  
**Luz media giratoria o fija. 1/2W AMA 12-24V**

LFL052



LFL054



LFL056



LFL060



LFL062



LFL064

**LICUADORA VASO INTERO AMARILLO 2 STROBER**  
**LED Luz media giratorio o fija. 1/2W AMA 12-24V**

**LMS017**  
STOP RENEGADO  
LED MULTIV 12-24V X1



## **PLAST INNOVA<sup>®</sup>**

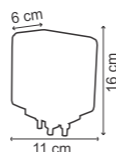

**LPF178**  
SEMAFO CUA 54  
LED L/COL AMA-ROJ DER MULTI

**Características:**  
Lampara direccional en leds resinada.  
54 Leds  
Lente color  
Conjunto tornilleria.

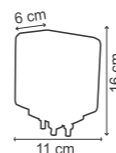

**LPF180**  
SEMAFO CUA 54  
LED L/COL AMA-ROJ IZQ MULTI

**Características:**  
Lampara direccional en leds resinada.  
54 Leds  
Lente color  
Conjunto tornilleria.



**LPF110**  
SEMAFO CUA 32  
LED L/COL AMA-ROJ 12V

**Características:**  
Lampara direccional en leds resinada.  
54 Leds  
Lente color  
Conjunto tornilleria.



**LPV006**  
ARO 1015  
VIS CROM

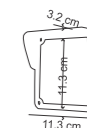





**LPL172**  
LAMP 1002 L/CRI  
16 LED AZU MULTI

**LPL170**  
LAMP 1002 L/CRI  
16 LED AMA MULTI

**LPL174**  
LAMP 1002 L/CRI 16  
LED BLA MULTI

**LPL176**  
LAMP 1002 L/CRI  
16 LED ROJ MULTI

**LPL178**  
LAMP 1002 L/CRI  
16 LED VER MULTI

**LPL180**  
LAMP 1002 L/AMA  
16 LED AMA MULTI

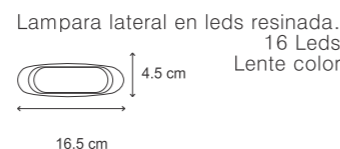
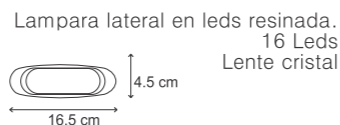

**LPL098**  
LAMP 1001 L/CRI 8  
LED AMA MULTI

**LPL102**  
LAMP 1001 L/CRI 8  
LED BLA MULTI



**LPL082**  
LAMP 1001  
L/CRI 8 LED AZU 12V



**LPL506**  
LAMP 1017 ARO ACE  
L/ROJ 24 LED AMA MULTI

Lampara lateral ovalada en  
leds resinada. 24 Leds  
Aro de seguridad en plástico o acero.  
Lente cristal o lente color.

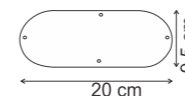

**LPL504**  
LAMP 1017 ARO ACE  
L/AMA 24 LED AMA MULTI

Lampara lateral ovalada en  
leds resinada. 24 Leds  
Aro de seguridad en plástico o acero.  
Lente cristal o lente color.

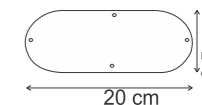



**LPS412**  
STOP 4" ARO ACE L/CRI 24  
LED BLA 12V



**LPS426**  
STOP 4" ARO ACE  
L/CRI 24 LED BLA MULTI

**LPS428**  
STOP 4" ARO ACE  
L/CRI 24 LED ROJ MULTI

**LPS432**  
STOP 4" ARO ACE  
L/AMA 24 LED AMA MULTI

**LPS434**  
STOP 4" ARO ACE  
L/ROJ 24 LED ROJ MULTI

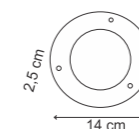

Lampara Stop en leds resinada.  
Aro en acero  
24 Leds





**LPS550**

STOP TRIPLE L/COL  
48 LED AMA-ROJ-BLA MULTI X1

**LPS548**

STOP TRIPLE L/COL  
48 LED AMA-ROJ-BLA12V X1



**LPS526**

STOP TRIPLE L/COL 72  
LED AMA-ROJ-BLA MULTI X1

# Catálogo de **Productos Truck**

**Ópticas** 

**MENÚ** 



**OPA005**  
OPT 4000 KTC  
RED PÑA 14.5CM X1



**OPB007**  
OPT 4652 KTC L/MED  
REC PÑA 16x10CM X1



**OPC008**  
OPT 6014 KTC L/MED RED  
GDE 18CM X1



**OPD010**  
OPT 6052 KTC L/MED REC  
GDE 20X14CM X1



**OPD009**  
OPTICA 6052 KTC RECTANGULAR  
GRANDE 20 X 14CM X 1



**OPU003**  
U SEL KTC H4656 REC PÑA  
12V 35/35W 16X10CM 3COT X1



**OPU005**  
U SELLADA KTC H6024 RED  
GDE 12V 65/40W 7" 3CONT X1



**OPU007**  
U SEL KTC H6054 REC GDE  
12V 65/35W 20x14CM 3COT X1



## OPD024

OPT R.GDE 45W 12/24V 9 LED DRL AZU 200X140X80 X1  
LED TOSHIBA



## OPD026

OPT R.GDE 45W 12/24V 9 LED DRL BLA 200X140X80 X1  
LED TOSHIBA





## OPD030

OPT R.GDE 45W 12/24V 9 LED DRL ROJ 200X140X80 X1  
LED TOSHIBA

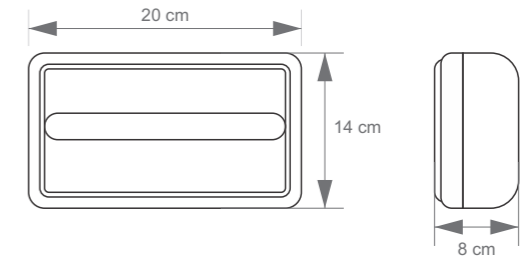

## OPD040

OPT R.GDE 45W 12/24V 15 LED 200X140X80 X1  
LED EPISTAR

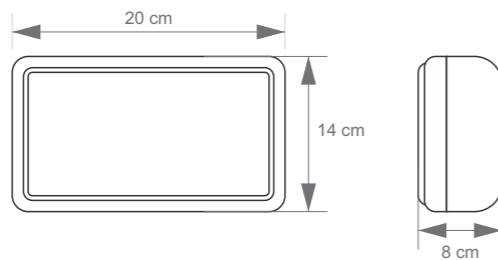



## OPD046

OPT R.GDE 45W 12/24V 15 LED O.AN BLA 200X140X80 X1  
LED EPISTAR

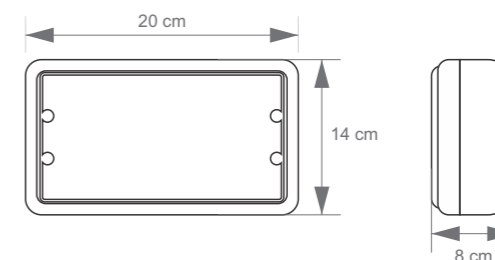

## OPD044

OPT R.GDE 45W 12/24V 15 LED O.AN AZU  
200X140X80 X1 LED EPISTAR

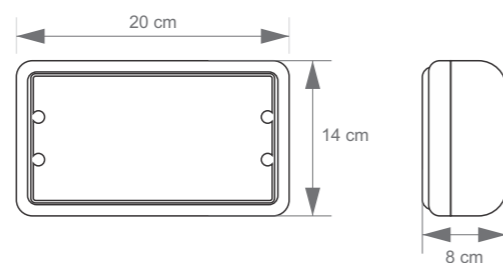



## OPB050

OPT R.GDE 45W 12/24V 15 LED O.AN ROJ 200X140X80 X1  
LED EPISTAR

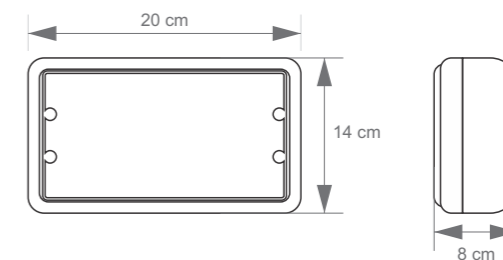

## OPB024

OPT R.PÑA 45W 12/24V 9 LED DRL AZU 165X105X75 X1  
LED TOSHIBA

  
DRL LUZ AZUL

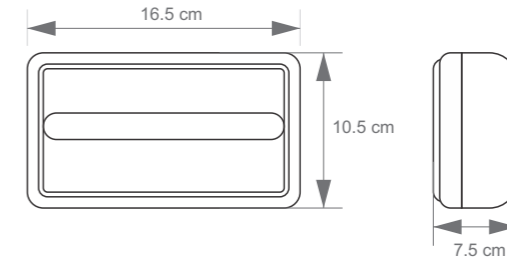

## OPB026

OPT R.PÑA 45W 12/24V 9 LED DRL BLA  
165X105X75 X1 LED TOSHIBA

  
DRL LUZ  
BLANCA

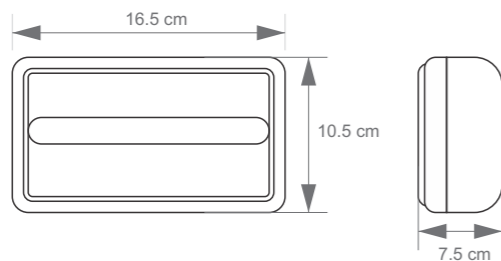



## OPB030

OPT R.PÑA 45W 12/24V 9 LED DRL ROJ 165X105X75 X1  
LED TOSHIBA

**DRL LUZ ROJO**

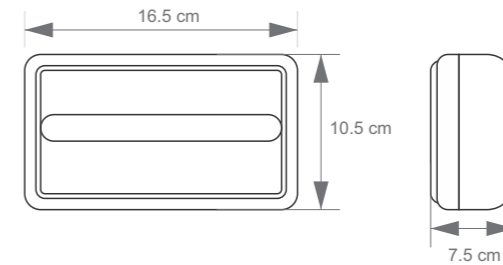

## OPB040

OPT R.PÑA 45W 12/24V 15 LED  
165X105X75 X1 LED EPISTAR

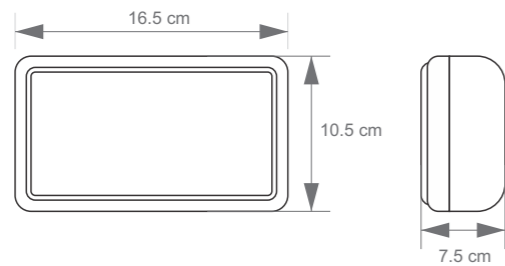



## OPB046

OPT R.PÑA 45W 12/24V 15 LED O.AN BLA 165X105X75 X1  
LED EPISTAR

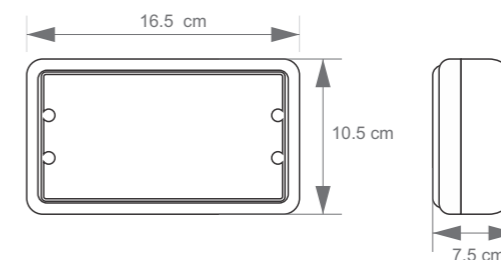

## OPB044

OPT R.PÑA 45W 12/24V 15 LED O.AN AZU 165X105X75 X1  
LED EPISTAR

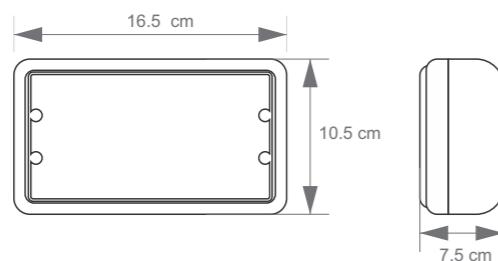



## OPB050

OPT R.PÑA 45W 12/24V 15 LED O.AN ROJ 165X105X75 X1  
LED EPISTAR

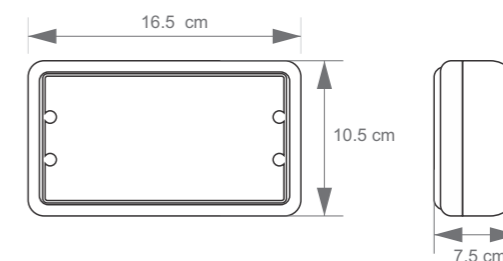



## **Accesorios**

**Antenas y Accesorios**

**Espaldares y Pellones**

**Manijas y Spoiler**

**Parasoles**

**Tapa Ejes**

**Tapa Tuerca**

**Tapa Válvulas**

**Tornillos de Lujo**



# Antenas

Producto

¡Nuevo!



**AND055**  
LATIGO ANTENA BLANCO  
DECORA 8.5X1.22MT X1  
303-D-T014



**AND056**  
LATIGO ANTENA BLANCO  
8.5X93CM X1  
303-D-T016

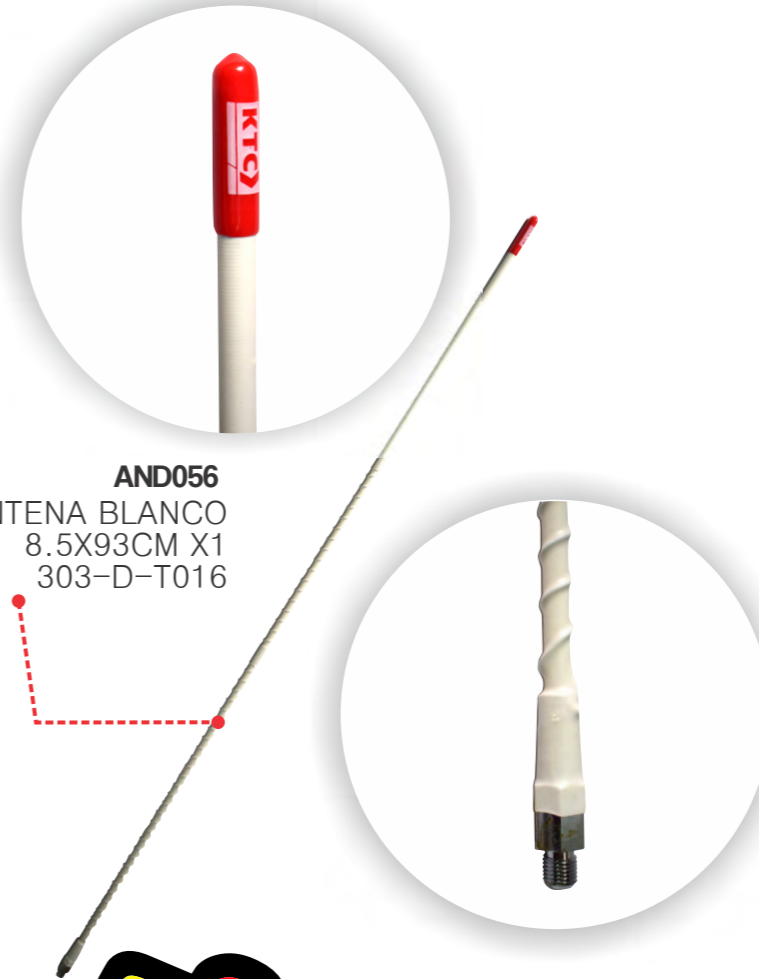

**arani**<sup>®</sup>

EL MEJOR MEDIO PARA SURTIR SU NEGOCIO



Arani Ltda



Lujos Arani Ltda



[www.arani.com.co](http://www.arani.com.co)





**AND052**  
LATIGO ANTENA  
BLANCO  
8.5X93CM (0.34"X36.62") X1

**AND050**  
LATIGO ANTENA BLANCO  
8.5X1.22MT X1



**AND064**  
BASE ANTENA CON 3  
ANTENAS CORTAS X1



**AND053**  
LATIGO ANTENA NEGRO  
8.5X1.20MT  
(0.34"X48.04") X1

**AND054**  
LATIGO ANTENA NEGRO  
8.5X90CM  
(0.34"X36.62") X1





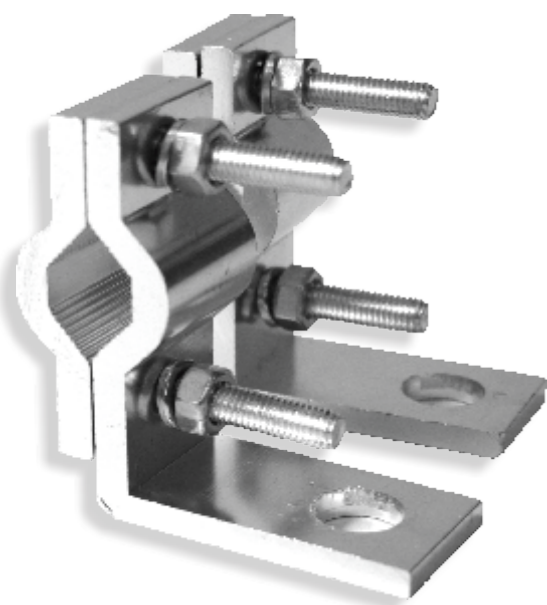

**AND062**  
BASE ANTENA  
PEQUEÑA EN FORMA  
DE L 2 TORN HRZ X2

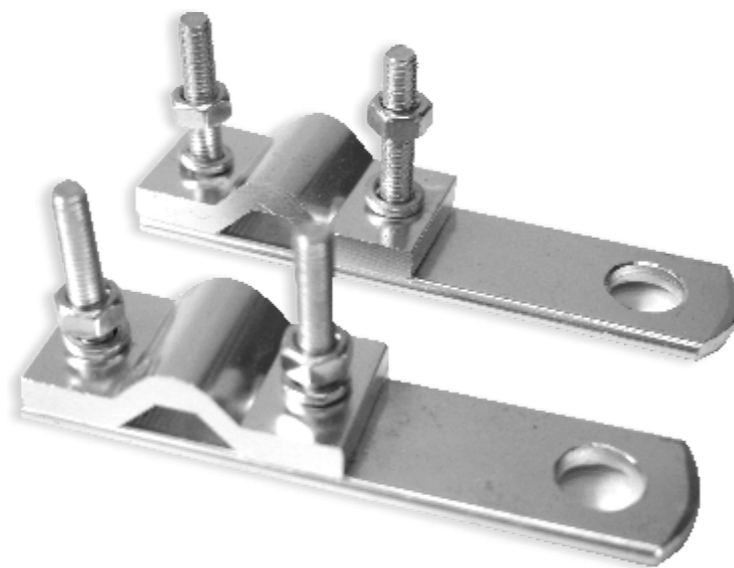

**AND063**  
BASE ANTENA  
PEQUEÑA EN FORMA  
RECTA 2 TORN HRZ X2

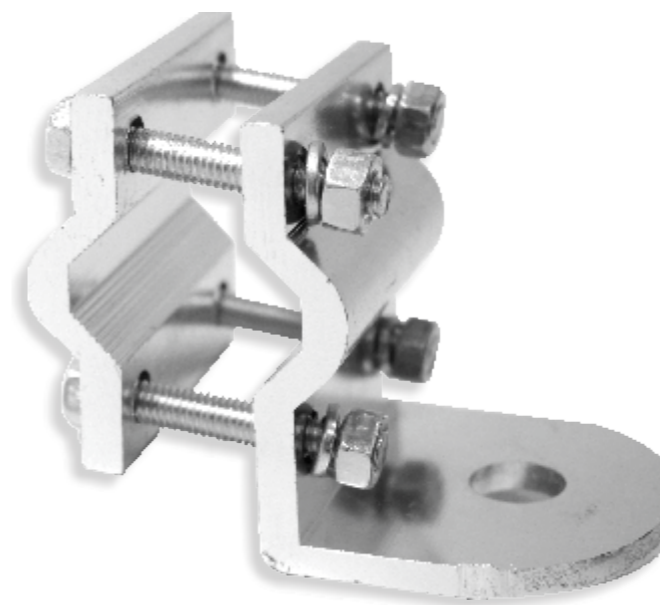

**AND061**  
BASE ANTENA  
PARA ESPEJO LATERAL  
4 TORN HRZ X1

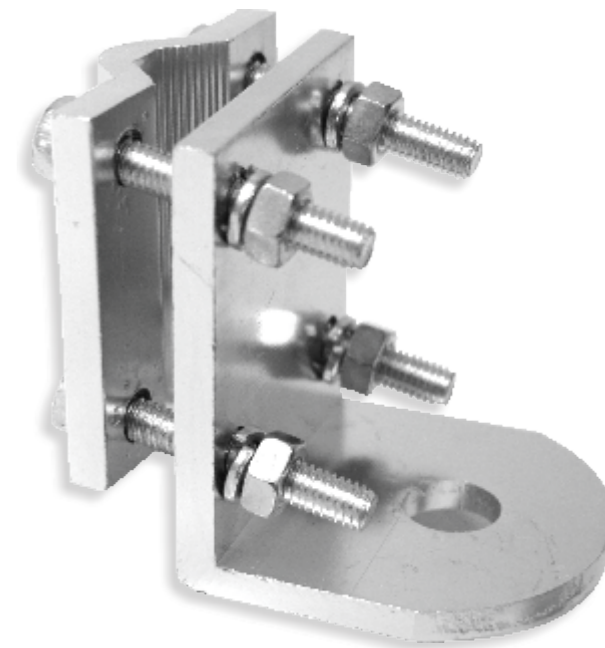

**AND060**  
BASE ANTENA PARA  
ESPEJO LATERAL  
4 TORN VERTICAL X1



**AND072**  
RESORTE LUJO  
ACERO PARA ANTENA  
DE CAMIÓN ANC X1



**AND076**  
RESORTE LUJO  
ACERO PARA ANTENA  
DE CAMIÓN DEL X1





**ACE050**  
VENTILADOR METALICO 6" 12V X1  
**ACE051**  
VENTILADOR METALICO 6" 24V X1



**GUA012**  
PLATINA SUPERIOR PARA GUARDAPOLVO  
CON REFLEC X2



**PBV040**  
PERA PARA  
VOLANTE EN ALUMINIO

## Espaldares ortopédicos

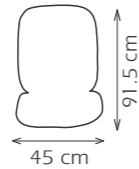

- EPC032** AZUL
- EPC034** GRIS
- EPC036** MADERA
- EPC038** NEGRO
- EPC040** ROJO

**Características:**

Proteger la tapicería original del vehículo. Producir un efecto fresco y relajante al conducir un vehículo.



**EPS005**  
FIGURAS



**EPS020**  
BEIGE



**EPS025**  
GRIS BORDE NEG

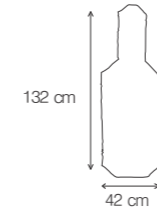

## Espaldares plásticos

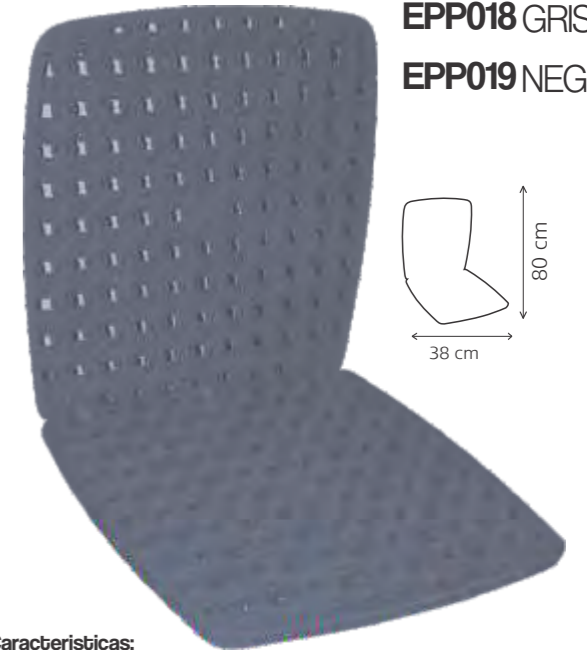

- EPP018** GRIS
- EPP019** NEGRO

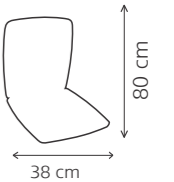

**Características:**

Proteger la tapicería original del vehículo. Producir un efecto fresco y relajante al conducir un vehículo.





**Pellon Alto**

- PLA001
- PLA002
- PLA004
- PLA005
- PLA006
- PLA003

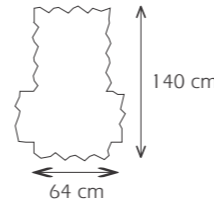

**Pellon Bus**

- PLB005
- PLB008
- PLB012
- PLB014
- PLB016
- PLB010



**Pellon Camión**

- PLC005
- PLC008
- PLC012
- PLC014
- PLC016
- PLC010

**MAE016**  
MANIJA PASTA GDE



**MAE020**  
MANIJA ZAMAT CORTA

**MAE022**  
MANIJA ZAMAT LARGA

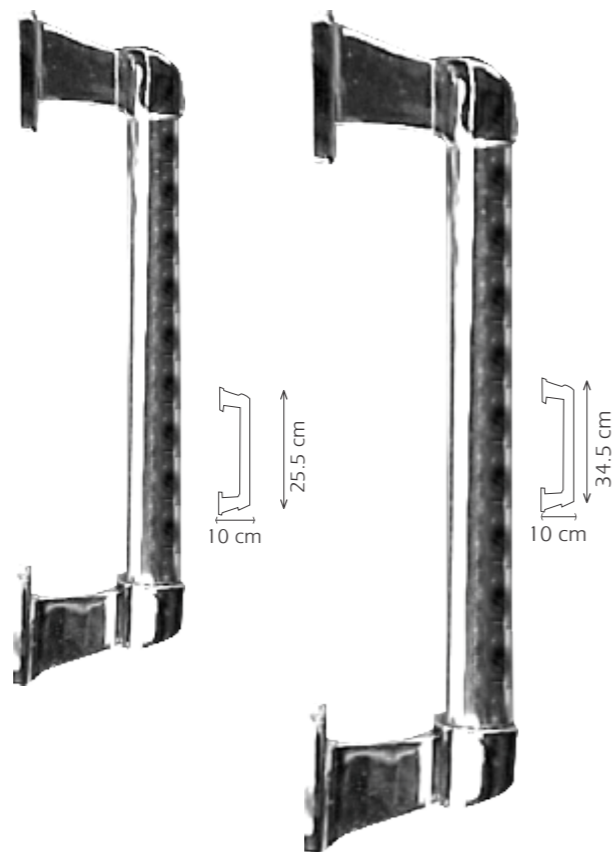

**SPU011**  
SPOILER PLUM LUJO  
CROM-CROM



Características:  
Pasta con recubrimiento cromado

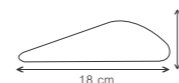

**SPU014**  
SPOILER PLUM LUJO  
CROM-AZU



Características:  
Pasta con recubrimiento cromado

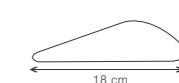

**SPU016**  
SPOILER PLUM LUJO  
CROM-CARBON



Características:  
Pasta con recubrimiento cromado

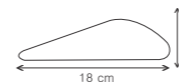

**SPU025**  
SPOILER PLUM LUJO  
CROM-ROJO



Características:  
Pasta con recubrimiento cromado

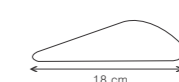



CPP022  
PARASOL POLARIZADO



Características:  
Película polarizada negra  
Retráctil

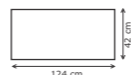

CPP026  
PARASOL MAGIC 200X70cm

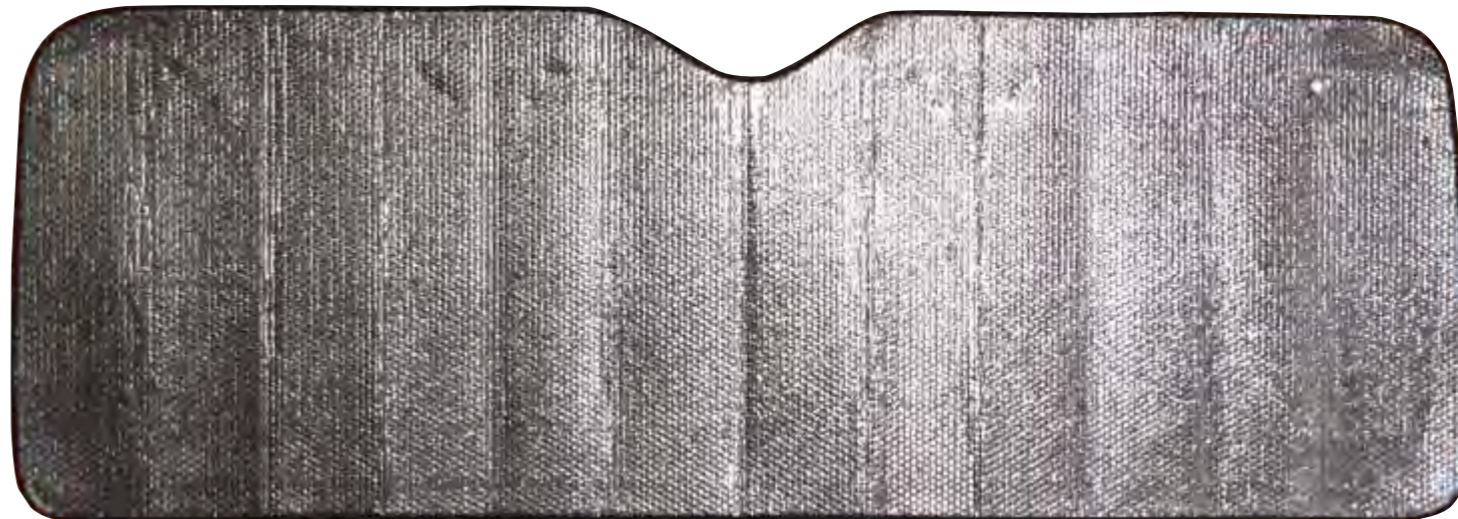

CPP027  
PARASOL MAGIC 220X80cm

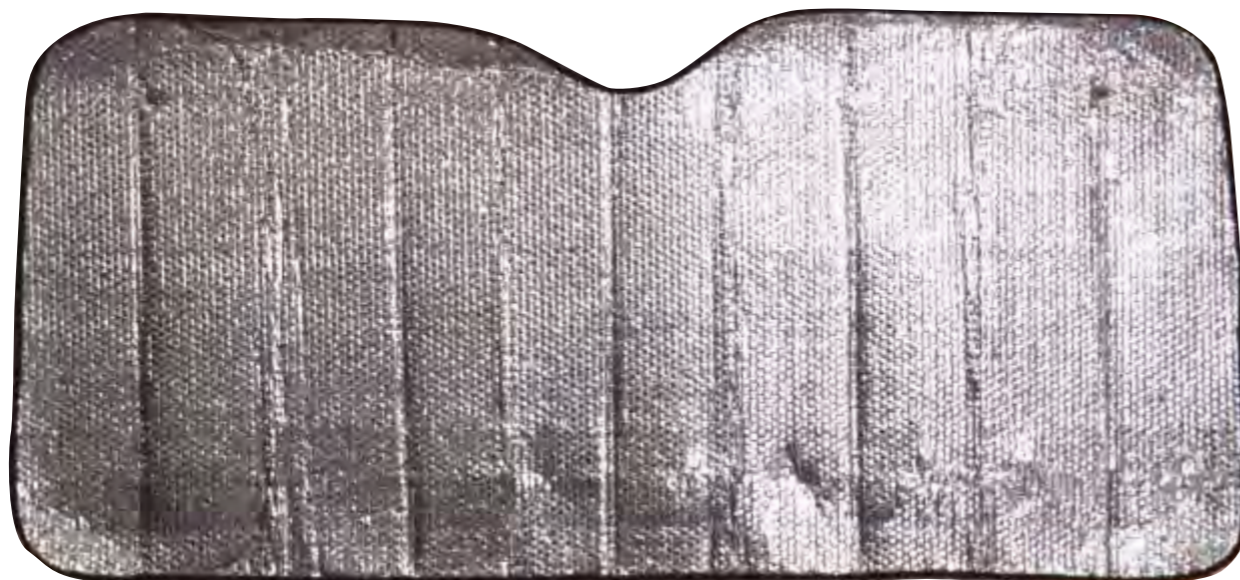

CPP025  
PARASOL MAGIC 150X70cm

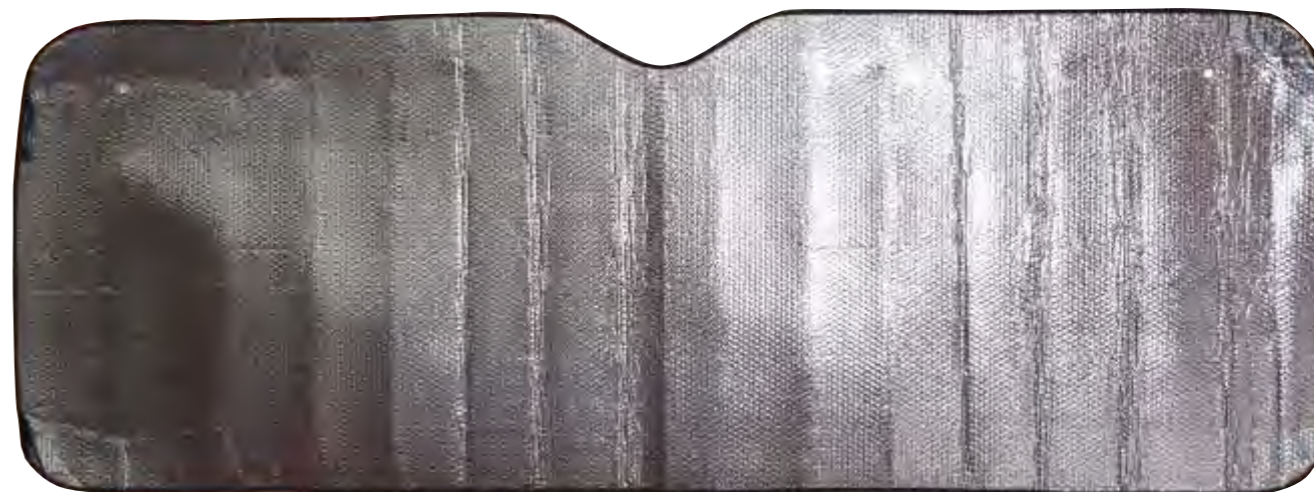

# Tapa Ejes

**Producto**

**¡Nuevo!**

**TPT570**  
T/EJE DEL CROM 7/16", 6 UÑ  
PTA DIAMANTE 310-



**TPT571**  
T/EJE DEL CROM 8 5/8", 6 UÑ  
PTA REDONDA 310-108-R





## TPT515

T/EJE TRA 2015TH ABS CROM  
HEXAGONAL CON/TPT X1



## TPT505

T/EJE DEL 2015DH ABS CROM  
HEXAGONAL CON/TPT X1



## TPT504

T/EJE DEL 35CM TPT33MM  
2015D ABS CROM SIN/TPT X1



\*No incluye tapa tuercas



## TPT508

T/EJE TRA 35CM TPT33MM 2015T  
ABS CROM SIN/TPT X1



\*No incluye tapa tuercas



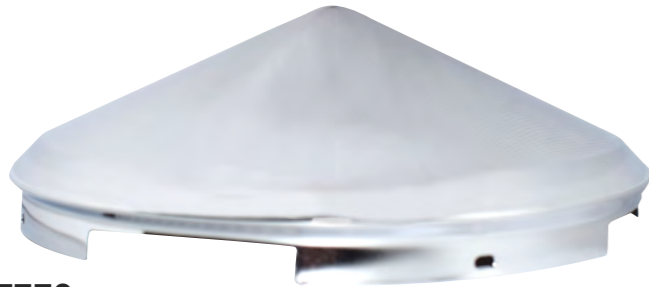

**TPT550**  
T/EJE DEL CROM 8 5/8" 4 UÑ PTA  
DIAMANTE-310-103-D



**TPT552**  
T/EJE DEL CROM 8 5/8" 4UÑ PTA RED MED  
LNA310-105R



**TPT560**  
T/EJE DEL CROM 8 5/8" 4UÑ PTA RED MED  
LNA310-105R



**TPT562**  
T/EJE DEL CROM 8 5/8" 4UÑ PTA RED MED  
LNA310-105R

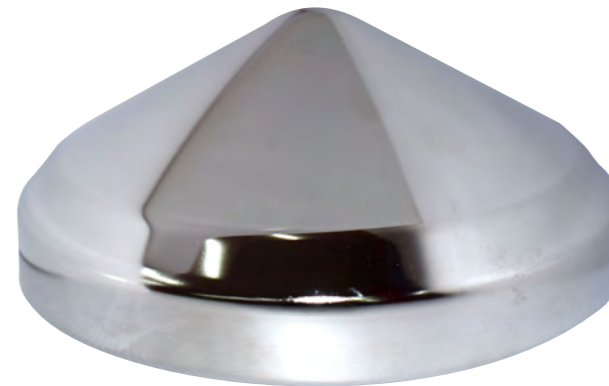

**TPT564**  
T/EJE DEL CROM 8 5/8" 4UÑ PTA RED MED  
LNA310-105R

## TPT172

T T/CA 33MM R D/CO P  
PLANA LISA ALTA 2020P X10



## TPT176

T T/CA 33MM R D/CO  
HEXAGONAL P 2021P X10



## TPT260

T T/CA 33MM R D/CO  
P PLANA LISA ALTA 2020R X10



## TPT264

T T/CA 33MM R D/CO  
HEXAGONAL P 2021R X10



## TPT282

T T/CA 41MM R D/CO  
P PLANA LISA ALTA 2020NP X10



## TPT284

T T/CA 41MM R D/CO  
HEXAGONAL P 2021NP X10



## TPT402

T/TORN 23 MM CHASIS P  
ESFERA KENWORTH 2022PK



## TPT404

T/TORN 23 MM CHASIS P  
HEXAGONAL KENWORTH 2023PK



## TPT406

T/TORN 23 MM CHASIS P  
PLANA LISA KENWORTH 2024PK



## TPT405

T/TORN 24 MM CHASIS P  
HEXAGONAL 2023P

## TPT407

T/TORN 24 MM CHASIS  
P PLANA LISA 2024P

## TPT403

T/TORN 24 MM CHASIS  
P ESFERA 2022P





## TPT170

T T/CA 33MM R D/CO P ESFERA  
2012P X10

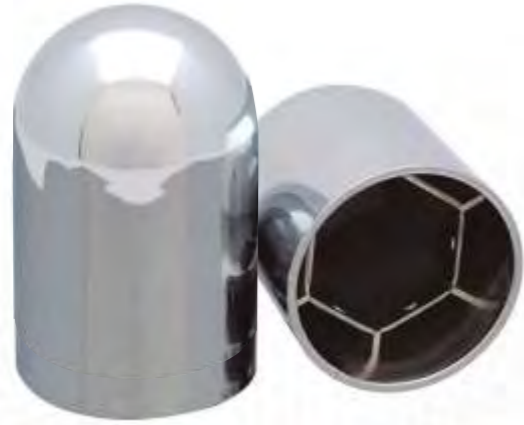

## TPT258

T T/CA 33MM R D/CO R ESFERA  
2012R X10



## TPT194

T T/CA 33MM R D/CO P PLANA  
HEX 2014P X10



## TPT262

T T/CA 33MM R D/CO R PLANA  
HEX 2014R X10



## TPT354

T T/CA 41MM NPR P  
CONO 2002P X5



## TPT362

T T/CA 41MM NPR P DIAMTE  
PRISM 2008PPP X5



## TPT366

T T/CA 41MM NPR P  
ESFERA 2006P X5



## TPT370

T T/CA 41MM NPR P PLANA  
CH/LET 2008PCH X5



## TPT430

T T/CA 33MM PTA RED-  
MET 310-306 X1



## TPT432

T T/CA 38MM PTA BAL-  
MET 310-303 X1



## TPT435

T T/CA 41MM PTA RED-  
MET 310-320 X1



## TPT441

T T/CA 41MM PTA RED-  
MET 310-320 X1



## TPT420

T T/CA 33MM PTA PNA-  
MET 310-305 X1



## TPT425

T T/CA 33MM PTA PNA-  
MET 310-308 X1





**TPT005**  
TP CACHO CAMPERO ABIERTO X1



**TPT008**  
TP CACHO CAMPERO CERRADO X1



**TVS006**  
TAPA VALVULA BOLA 8 AZUL



**TVS008**  
TAPA VALVULA BOLA 8 NEGRO



**TVS010**  
TAPA VALVULA BOLA 8 ROJO



**TVS009**  
TAPA VALVULA BOLA 8 PLATEADO





**TVS018**  
TAPA VALVULA CABEZA  
BALA PLATA



**TVS020**  
TAPA VALVULA CABEZA  
BALA AZUL



**TVS022**  
TAPA VALVULA CABEZA  
BALA ROJO



**TVS028**  
TAPA VALVULA CABEZA PLANA ROJO



**TVS024**  
TAPA VALVULA CABEZA PLANA PLATA



**TVS054**  
TAPA VALVULA  
PUNTA PLATEADO

**TVS053**  
TAPA VALVULA  
PUNTA NEGRO

**TVS055**  
TAPA VALVULA  
PUNTA ROJO



**TVS051**  
TAPA VALVULA  
PUNTA AZUL

**TVS052**  
TAPA VALVULA  
PUNTA MORADO

**TVS050**  
TAPA VALVULA  
PUNTA AMARILLO



## *Tapa valvula punta corta*



TVS040



TVS041



TVS042



TVS043



TVS044



TVS045



TVS046

## Tapa válvula dados



TVS061



TVS063



TVS064



TVS065



## TORNILLO LUJO PESA BRISTOL 6mm / 2.5cm

TRL040

TRL041

TRL042

TRL043

TRL044

TRL045

TRL047

TRL049

TRL051



## TORNILLO LUJO ESTRELLA BRISTOL 6mm / 2.5cm

TRL060

TRL061

TRL062

TRL063

TRL064

TRL065

TRL066





## TORNILLO LUJO REDONDO / RAYAS BRISTOL 6mm / 2.5cm



## TORNILLO LUJO REDONDO BRISTOL 6mm / 2.5cm





## TORNILLO LUJO CONICO BRISTOL 6mm / 2.5cm

TRL100



TRL101



TRL102



TRL103



TRL104



TRL105



TRL106







## **Pitos**

**Pito Corneta**

**Pitos Caracol**

**Pitos Disco**

**Pito Reversa**



Catálogo de **Productos Truck**

**Pitos Caracol** 

**MENÚ** 



**PIC003**  
PITO CARAC HELLA  
410HZ/510HZ  
NEG 86MM 24V X2



**PIC002**  
PITO CARAC HELLA  
410HZ/510HZ  
CROM 86MM 12V X2





Catálogo de **Productos Truck**

**Pitos Corneta** 

**MENÚ** 





**Producto**  
**¡Nuevo!**



**PIC026**  
PITO CORN 3COR KTC CROM  
CON ELE/VALVULA 12V-24V X1

← 3 Cornetas cromadas



**PIC027**  
PITO CORN 4COR KTC CROM  
CON ELE/VALVULA 12V-24V X1

4 Cornetas cromadas con un sonido más fuerte

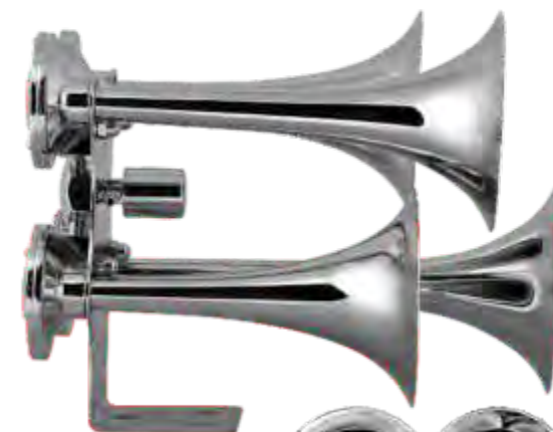

**PIC029**  
PITO TREN 4COR KTC CROM CON  
ELE/VALVULA 12V-24V X1

4 cornetas cromadas con sonido de Tren, para que te escuchen a kilometros







**PIC023**

PITO CORN 2COR KTC  
CROM CON ELE/VALVULA  
12V-24V X1



**PIE005**

ELECTROVALVULA KTC  
PITO CORNETA 12V-24V X1



# Catálogo de **Productos Truck**

***Pitos Disco*** 

**MENÚ** 





**PID024**  
PITO DISC HELLA 335HZ/435HZ  
NEG 92MM 24V X2



**PID050**  
PITO DISC BOSCH  
420HZ NEG 92MM 24V X1



**PID051**  
PITO DISC BOSCH  
350HZ NEG 92MM 24V X1



## YARTON NIKI

**PID038**  
PITO DISC YARTON 290HZ/345HZ  
CROM-NEG 132MM 24V X2





Catálogo de **Productos Truck**

**Pitos Reversa** 

**MENÚ** 



**PIR013**  
PITO REVER 1TON BEE-BEE  
NEG 62MM 12V-24V X1



**PIR025**  
PITO REVER HELLA 1TON  
BEE-BEE NEG 67MM 9-48V X1





## **Cuidado y embellecimiento**

**Ambientadores**

**Betún y Ceras**

**Limpiadores**

**Lubricantes**

**Restauradores**

**Siliconas**



# Catálogo de **Productos Truck**

**Ambientadores** 

**MENÚ** 

# SIMONIZ®

AMBIENTADOR  
SHICK DUO

**AMG090**  
CITRUS

**AMG091**  
FRESA



**AMG095**  
AMB SHICK GEL  
DUO PACK MANZ



**AMG087**  
AMB SHICK GEL  
DUO PACK C/NUEVO



**AMG084**  
AMB SHICK GEL  
DUO PACK AQUA



**AMG089**  
AMB SHICK GEL  
DUO PACK CHICLE





# SIMONIZ®



AMBIENTADOR  
SHICK SX  
GIRATORIO 10ML

**AML095**  
BRISA

**AML096**  
CHICLE

**AML097**  
COLONIA

**AML099**  
FRESA



AMB SHICK  
SPLASH 2 AROMAS

**AML150**  
CARRO NUEVO Y  
COL FRESCA

**AML154**  
FRESA Y  
VAINILLA



**AML118**  
AMB SHICK FRESH  
CAR BLACK ICE 110ML



AMBIENTADOR  
SHICK PREMIUM

**AML106**  
CHICLE

**AML108**  
CARRO NUEVO

**AML109**  
FRESA



**AML023**  
AMB COLONIAL  
KRAMER 135 CC



**AML027**  
AMB COLONIAL  
KRAMER 60CC

**AML029**  
AMB COLONIAL  
KRAMER BLACK 60CC



**AML031**  
AMB COLONIAL  
KRAMER BLUE 60CC



**AML033**  
AMB COLONIAL  
KRAMER FARA 60CC



**AML035**  
AMB COLONIAL  
KRAMER GOLD 60CC







**AMS043**  
AMB FRESA AIR  
FRESHENER X1



**AMS042**  
AMB CHICA  
FRESA ORIGINAL X1



**AMS050**  
AMB FRESITA  
ECONOMICA



**AMS064**  
AMB PICADURA  
TABACO



**AML057**  
AMB PICADURA  
LIQUIDA 20Z



**AML008**  
AMB MI CHICA  
FRESITA LIQUIDA 60ML





# Ambientadores

# Catálogo de Productos Truck



dissan



**AML162**  
Fragancia  
CITRUS

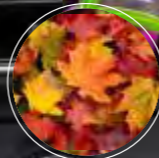

**AML166**  
Fragancia  
HOJAS DE  
OTOÑO



**AML170**  
Fragancia  
UVA



**AML164**  
Fragancia  
FRUTATROPICAL



**AML168**  
Fragancia  
MANDARINA

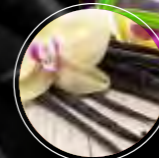

**AML172**  
Fragancia  
VAINILLA



**areon**<sup>®</sup>  
QUALITATIVE PARFÜME

**AMP012**  
AMB AREON CARTÓN  
BLACK CRISTAL X1



Duración aproximada:  
15 días clima cálido.  
12 días clima frío.

**AMP016**  
AMB AREON CARTÓN  
CARRO NUEVO X1



Duración aproximada:  
15 días clima cálido.  
12 días clima frío.

**AMP018**  
AMB AREON CARTÓN  
CHICLE X1



Duración aproximada:  
15 días clima cálido.  
12 días clima frío.

**AMP020**  
AMB AREON CARTÓN  
FRESA X1



Duración aproximada:  
15 días clima cálido.  
12 días clima frío.

**AMP024**  
AMB AREON CARTÓN  
LIMON X1



Duración aproximada:  
15 días clima cálido.  
12 días clima frío.

**AMP026**  
AMB AREON CARTÓN  
MANZANA CANELA X1



Duración aproximada:  
15 días clima cálido.  
12 días clima frío.

**AMP042**  
AMB AREON CARTÓN LIQUIDO  
BLACK CRISTAL 5ML X1



Duración aproximada:  
Varía en clima cálido.  
35 días clima frío.

**AMP046**  
AMB AREON CARTÓN LIQUIDO  
CARRO NUEVO 5ML X1



Duración aproximada:  
Varía en clima cálido.  
35 días clima frío.

**AMP048**  
AMB AREON CARTÓN  
LIQUIDO CHICLE 5ML X1



Duración aproximada:  
Varía en clima cálido.  
35 días clima frío.

## areon® QUALITATIVE PARFÜME

**AMP224**  
AMB AREON  
MEMBRANA  
ICEBERG 8ML X1



⌚ Duración aproximada:  
Varía en clima cálido.  
75 días clima frío.

**AMP220**  
AMB AREON  
MEMBRANA  
DURAZNO 8ML X1



⌚ Duración aproximada:  
Varía en clima cálido.  
75 días clima frío.

**AMP216**  
AMB AREON  
MEMBRANA  
CHICLE 8ML X1

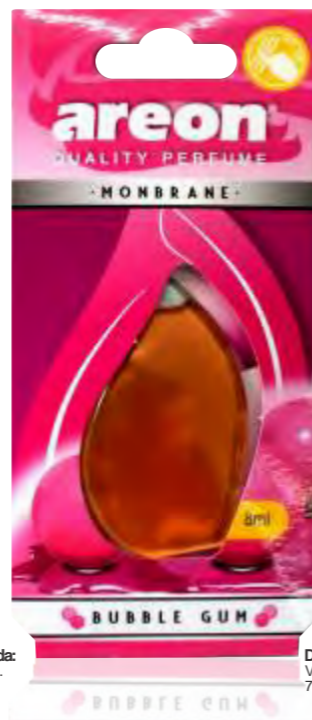

⌚ Duración aproximada:  
Varía en clima cálido.  
75 días clima frío.

**AMP230**  
AMB AREON  
MEMBRANA  
TORTUGA 8ML X1



⌚ Duración aproximada:  
Varía en clima cálido.  
75 días clima frío.

**AMP218**  
AMB AREON  
MEMBRANA  
CITRUS 8ML X1



⌚ Duración aproximada:  
Varía en clima cálido.  
75 días clima frío.



**AMP056**

AMB AREON CARTÓN LIQUIDO  
MANZANA CANELA 5ML X1



Duración aproximada:  
Varía en clima cálido.  
35 días clima frío.

**AMP060**

AMB AREON CARTÓN LIQUIDO  
OXIGEN 5ML X1



Duración aproximada:  
Varía en clima cálido.  
35 días clima frío.

**AMP082**

AMB AREON CARTÓN  
SPORT LUX GOLD X1



Duración aproximada:  
15 días clima cálido.  
12 días clima frío.

**AMP084**

AMB AREON CARTÓN  
SPORT LUX PLATINUM X1



Duración aproximada:  
15 días clima cálido.  
12 días clima frío.

**AMP086**

AMB AREON CARTÓN  
SPORT LUX SILVER X1



Duración aproximada:  
15 días clima cálido.  
12 días clima frío.

**AMP090**

AMB AREON GEL BLACK  
CRISTAL 80G X1



Duración aproximada:  
60 días clima cálido.  
90 días clima frío.

**AMP092**

AMB AREON GEL  
CHICLE 80G X1



Duración aproximada:  
60 días clima cálido.  
90 días clima frío.

**AMP094**

AMB AREON GEL  
FRESA 80G X1



Duración aproximada:  
60 días clima cálido.  
90 días clima frío.

**AMP096**

AMB AREON  
GEL LIMÓN 80G X1



Duración aproximada:  
60 días clima cálido.  
90 días clima frío.

**AMP098**

AMB AREON GEL  
PASSION 80G X1



Duración aproximada:  
60 días clima cálido.  
90 días clima frío.



**AMP112**  
AMB AREON  
LIQUIDO CAR  
AIRE GOLD 8ML X1

⌚  
Duración aproximada:  
Varía en clima cálido.  
60 días clima frío.



**AMP114**  
AMB AREON  
LIQUIDO CAR  
AIRE OXIGEN 8ML X1

⌚  
Duración aproximada:  
Varía en clima cálido.  
60 días clima frío.



**AMP116**  
AMB AREON  
LIQUIDO CAR AIRE  
PLATINUM 8ML X1

⌚  
Duración aproximada:  
Varía en clima cálido.  
60 días clima frío.



**AMP118**  
AMB AREON  
LIQUIDO CAR  
AIRE SILVER 8ML X1

⌚  
Duración aproximada:  
Varía en clima cálido.  
60 días clima frío.



**AMP122**  
AMB AREON  
LIQUIDO FRESCO  
BLACK CRISTAL 4ML X1

⌚  
Duración aproximada:  
Varía en clima cálido.  
60 días clima frío.



**AMP124**  
AMB AREON  
LIQUIDO FRESCO  
CARRO NUEVO X 4ML X1

⌚  
Duración aproximada:  
Varía en clima cálido.  
60 días clima frío.



**AMP126**  
AMB AREON  
LIQUIDO FRESCO  
CHICLE 4ML X1

⌚  
Duración aproximada:  
Varía en clima cálido.  
60 días clima frío.



**AMP128**  
AMB AREON  
LIQUIDO FRESCO  
FRESA 4ML X1

⌚  
Duración aproximada:  
Varía en clima cálido.  
60 días clima frío.



**AMP130**  
AMB AREON  
LIQUIDO FRESCO  
LIMÓN 4ML X1

⌚  
Duración aproximada:  
Varía en clima cálido.  
60 días clima frío.



# areon®

QUALITATIVE PARFÜME



**AMP146**  
AMB AREON LIQUIDO  
PERFUME  
CHICLE 35ML X1



 Duración aproximada:  
90 días según uso.



**AMP148**  
AMB AREON  
LIQUIDO PERFUME  
FRESA 35ML X1



 Duración aproximada:  
90 días según uso.



**AMP150**  
AMB AREON  
LIQUIDO PERFUME  
MANZANA CANELA 35ML X1



 Duración aproximada:  
90 días según uso.



**AMP132**  
AMB AREON LIQUIDO  
FRESCO MANZANA  
CANELA 4ML X1

 Duración aproximada:  
Varia en clima cálido.  
60 días clima frío.



**AMP134**  
AMB AREON LIQUIDO  
FRESCO OXIGEN  
4ML X1

 Duración aproximada:  
Varia en clima cálido.  
60 días clima frío.



**AMP142**  
AMB AREON  
LIQUIDO PERFUME  
BLACK CRISTAL 35ML X1



 Duración aproximada:  
90 días según uso.



**AMP144**  
AMB AREON  
LIQUIDO PERFUME  
CARRO NUEVO 35ML X1



 Duración aproximada:  
90 días según uso.

**areon**<sup>®</sup>  
QUALITATIVE PARFÜME

## AMP154

AMB AREON LIQUIDO  
PERFUME PREMIUM  
50ML GOLD X1



⌚ Duración aproximada:  
120 días según uso.

## AMP156

AMB AREON LIQUIDO  
PERFUME PREMIUM  
50ML PLATINUM X1



⌚ Duración aproximada:  
120 días según uso.

## AMP158

AMB AREON LIQUIDO  
PERFUME PREMIUM  
50ML SILVER X1



⌚ Duración aproximada:  
120 días según uso.



⌚ Duración aproximada:  
Varía en clima cálido.  
90 días clima frío.

**AMP162**  
AMB AREON LIQUIDO  
STICK BLACK  
CRISTAL X 85ML X1



⌚ Duración aproximada:  
Varía en clima cálido.  
90 días clima frío.

**AMP164**  
AMB AREON LIQUIDO  
STICK CHICLE  
X 85ML X1



⌚ Duración aproximada:  
Varía en clima cálido.  
90 días clima frío.

**AMP166**  
AMB AREON LIQUIDO  
STICK FRESA  
X 85ML X1



**AMP184**

AMB AREON ORGÁNICO  
KEN CARRO NUEVO X1

⌚  
Duración aproximada:  
60 días clima cálido.  
45 días clima frío.



**AMP186**

AMB AREON ORGÁNICO  
KEN CHICLE X1

⌚  
Duración aproximada:  
60 días clima cálido.  
45 días clima frío.



**AMP188**

AMB AREON ORGÁNICO  
KEN FRESA X1

⌚  
Duración aproximada:  
60 días clima cálido.  
45 días clima frío.



**AMP178**

AMB AREON LIQUIDO  
VENT 7 OXYGEN 7ML X1

⌚  
Duración aproximada:  
Varía en clima cálido.  
45 días clima frío.

**AMP190**

AMB AREON ORGÁNICO  
KEN LIMÓN X1

⌚  
Duración aproximada:  
60 días clima cálido.  
45 días clima frío.



**AMP182**

AMB AREON ORGÁNICO  
KEN BLACK CRISTAL X1

⌚  
Duración aproximada:  
60 días clima cálido.  
45 días clima frío.



**AMP192**

AMB AREON ORGÁNICO  
KEN MANZANA CANELA X1

⌚  
Duración aproximada:  
60 días clima cálido.  
45 días clima frío.



**AMP204**

AMB AREON PERLAS  
CHICLE X1

⌚  
Duración aproximada:  
45 días clima cálido.  
30 días clima frío.



**AMP202**

AMB AREON PERLAS  
BLACK CRISTAL X1

⌚  
Duración aproximada:  
45 días clima cálido.  
30 días clima frío.



# Catálogo de **Productos Truck**

**Betún y Ceras** 

**MENÚ** 





**CEC015**  
BETUN NEGRO  
BOWY 1 1/2Kg

**CEC013**  
BETUN NEGRO  
BOWY 1 Kg

**CEC011**  
BETUN NEGRO  
BOWY 325gr

**CEC085**  
CERA SIMONIZ LIMPIA VINIL 200GR X1



**CEL027**  
CERA SIMONIZ AUTOBRILLANTE 300ML X1

**CEC075**  
CERA SIMONIZ  
INSTABRILLO  
AEROSOL 480ML X1



# Betún y Ceras

# Catálogo de Productos Truck

**CEC019**  
CERA SIMONIZ RUBBING  
395 GR

**CEC018**  
CERA SIMONIZ RUBBING  
200 GR



**CEC079**  
CERA SIMONIZ SIEMPRE NUEVO  
300GR

**CEC080**  
CERA SIMONIZ SIEMPRE NUEVO  
200GR

**CEL003**  
CERA SIMONIZ LIQUIDA SIEMPRE  
NUEVO 500ML X1



**CEC021**  
CERA SIMONIZ SUPER  
POLY TEFLON 225GR



**CEC029**  
CERA SIMONIZ  
VISTA 255GR



**CEL020**  
CERA SIMONIZ SUPER  
BLUE 600ML  
**CEL019**  
SUPER BLUE 300ML



**CEL022**  
CERA SIMONIZ SUPER BLUE  
TEFLON 500ML



CERA SIMONIZ LIQUIDA 300ML

**CEL006**

**CEL009**

**CEL013**

**CEL015**

**CEL017**



**CEL010**  
CERA SIMONIZ LIQUIDA BLA 500ML  
**CEL014**  
NEG 500ML  
**CEL016**  
ROJ 500ML



**CES010**  
SHAMPOO SIMONIZ CERA  
AUTOBRILLANTE 300ML  
**CES011**  
600ML





# Catálogo de **Productos Truck**

**Limpiadores**



**MENÚ** ▶

# SIMONIZ®



**LLL020**  
LIMPIADOR SIMONIZ  
TAPICERIA ESPUMA 400ML



**LLL008**  
LIMPIADOR  
LLANTAX 500ML



**LLL018**  
LIMPIADOR ELECTRONICO  
SIMONIZ 240ML



**LLL035**  
LIMPIADOR SIMONIZ  
FARO MÁGICO 200ML X1



**LLL040**  
LIMP SIMONIZ CUERO CON  
ACONDICIONADOR 240ML X1



**CES015**  
LAVADO ECOLÓGICO  
SIN AGUA  
SIMONIZ 1000ML X1



**LLE008**  
ESTOPA GRANDE 250 GR



**LLE005**  
ESTOPA PEQUEÑA 125GR



**LLL001**

PAÑOS MICROFIBRA SIMONIZ  
SIEMPRE NUEVO X 4 Und



## SIMONIZ®



**LLL045**  
LIQUIDO SIMONIZ  
ANTIEMPAÑANTE 120ML X1



**LLL002**  
ADITIVO LIMPIABRISAS  
COJIN 30ML



# Catálogo de **Productos Truck**

**Lubricantes** 

**MENÚ** 



## YA LLEGO !!

# LUBRImota

LUBRICANTE MULTIFUNCIÓN

**NUEVO  
PRODUCTO**

ADQUIERELO YA



**LUBRICA**

**PIEZAS MOVILES**

Bisagras, cerraduras,  
ruedas, cadenas



**LIMPIA**

**SUCIEDAD**

Grasa, aceite,  
alquitrán y adhesivos



**DESPLAZA**

**HUMEDAD**

Sistemas eléctricos  
y bujías



**PROTEGE**

**SUPERFICIES**

Del óxido y la corrosión



**PENETRA**

**DESBLOQUEO**

De piezas atascadas

**LLU002**

LUBRICANTE LUBRIMOTA AEROSOL 216 ML X1

**LLU001**

LUBRICANTE LUBRIMOTA AEROSOL 125 ML X1



**SIMONIZ®**



**LLU010**

LUBRICANTE SIMONIZ ZX  
4 250ML

Catálogo de **Productos**

**Restauradores**

MENÚ ►



# Restauradores

## SIMONIZ®



**CER003**  
RENOV. DE LLANTAS  
SIMONIZ  
AEROSOL 400ML X1



**CER001**  
RESTAURADOR SIMONIZ  
NEGRO MÁGICO 250ML



**LLL031**  
RENOVADOR DE  
LLANTAS BOWLY 500ML

Evita el agrietamiento,  
mejora el brillo y repele el  
polvo por más tiempo de  
superficies como cauchos,  
gomas, neumáticos, fibra  
de vidrio, cueros y vinilos.

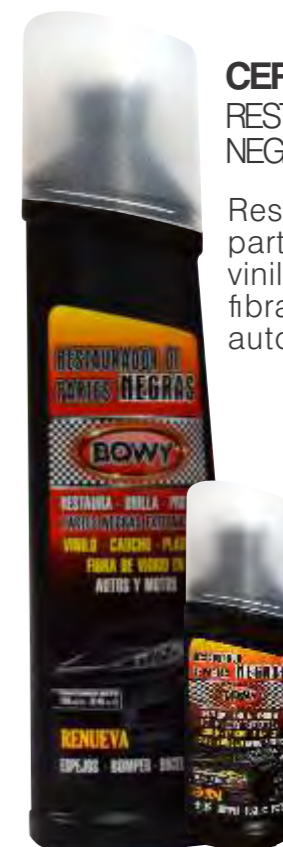

**CER012**  
RESTAURADOR PARTES  
NEGRAS BOWLY 250 ML

Restaura, brilla, protege  
partes negras externas de  
vinilo, caucho, plástico,  
fibra de vidrio en  
automóviles y motocicletas.

# Catálogo de **Productos Truck**

**Siliconas** 

**MENÚ** 



# Siliconas

## Producto

## ¡Nuevo!

# Silicona Sili-k



FRESA / SIA019



LIMÓN / SIA018



UVA / SIA020



Contenido del producto  
378cm<sup>3</sup> (12.8 Oz)



Conduce sin ruidos molestos en tu vehículo por la fricción de piezas.



Previene daños en las piezas móviles de tu vehículo.



Nada más agradable que un carro limpio, brillante y con un buen aroma en su interior.



Facilidad en la lubricación de piezas.





SILICONA  
300 ml

- SIL008 CITRUS
- SIL010 CHICLE
- SIL014 FRESA
- SIL016 PICADURA T.

SILICONA  
120 ml

- SIL006 FRESA

SIA038  
SILICONA UV3  
SIMONIZ CITRUS  
AEROSOL 400ML X1



SIA044  
SILICONA UV3  
SIMONIZ FRESA  
AEROSOL 400ML X1



SIL020  
SILICONA SIEMPRE  
NUEVO C/NUEVO 300ML



## SIMONIZ®

**SIA032**

SILICONA SIMONIZ ULTRA  
RAPIDA 300ML



**SIL164**

SILICONA UV BOWY  
CHICLE 160 ML X1



**SIL166**

SILICONA UV BOWY  
CITRUS 160 ML X1

**SIL170**

SILICONA UV BOWY  
TABACO 160 ML X1

**SIL168**

SILICONA UV BOWY  
FRESA 160 ML X1

**SIL162**

SILICONA UV BOWY  
BOUQUET 160 ML X1





**SIL184**  
SILICONA UV BOWY  
CHICLE 350 ML X1

**SIL186**  
SILICONA UV BOWY  
CITRUS 350 ML X1

**SIL190**  
SILICONA UV BOWY  
TABACO 350 ML X1

**SIL188**  
SILICONA UV BOWY  
FRESA 350 ML X1

**SIL182**  
SILICONA UV BOWY  
BOUQUET 350 ML X1







◀ SIL202  
CAR FRESH



◀ SIL206  
CHICLE



◀ SIL208  
FRESA



◀ SIL204  
CITRUS

# Sili-K

Aplicala sobre **vinilo, plástico, cuero y caucho.**

Cuida el interior de tu auto



Dale un **brillo intenso** a tu auto.



Brinda un **delicioso aroma** al interior de tu auto.





SIA008 SQ LIMON



SIA012 SQ UVA



SIA011 SQ FRESA  
SIA511X24 UND



SIL030  
SILICONA KRAMER  
MULTIUSOS EMUL  
TUTTY 250CC





**Alarmas**

**Max Security**  
ALARMAS Y ACCESORIOS



**Alarmas**

# Catálogo de **Productos Truck**

**Alarmas** 

**MENÚ** 



KTA606

ALARMA MAX SECURITY X1 206 X1

ALARMA VEHICULAR

## MaxSecurity

Contiene:

- Unidad principal.
- 2 controles 370 Mhz.
- Sensor de choque externo.
- Sirena de 6 tonos 20w.
- Botón valet.
- Puntilla capo.
- Led indicador.
- Arnés con porta fusible.
- Relay de 5 pines.
- Cables de instalación.



# X1

CONTROLES ANTI-CLON

Armado y desarmado

Armado y desarmado modo silencioso

Apertura de baúl

Desarmado modo valet

Antiasalto

Función de Pánico

Función de Seguros Eléctricos

Función de vidrios eléctricos

Función de salida de segundo y tercer canal

Función Turbo Timer



## X1 Alarma Vehicular

- Unidad principal.
- 2 Controles 370 MHz.
- Sensor de Choques externo.
- Sirena de 6 Tonos 20w.
- Botón valet.
- Puntilla capo.
- Led indicador.
- Arnés con porta fusible.
- Relay de 5 pines.
- Cables de instalación.



**KTA624**  
Alarma  
Max Security X1  
604 - M46 X1



**KTA625**  
Alarma  
Max Security X1  
625 - M87 X1



**KTA634**  
Alarma  
Max Security X1  
234 - F30 X1



**KTA635**  
Alarma  
Max Security X1  
235- F09 X1



**KTA637**  
Alarma  
Max Security X1  
237- F19 X1







## **Seguridad Vehicular**

**Asistentes de Parqueo**

**Botiquines**

**Cinturones**

**Extintores y soportes**

**Gatos Hidráulicos**

**Herramientas**

**Señales Reflectivas**



Arani Ltda



Lujos Arani Ltda



[www.arani.com.co](http://www.arani.com.co)



# Catálogo de **Productos Truck**

**Asistentes de  
Parqueo** 

**MENÚ** ▶





**KTS200**  
SENSOR REVERSA ESPEJO RETROVISOR 4 SENSORES



Monitor de parqueo



140°  
Grados de visión



**KTS204**  
ASIS-PARQ 4SEN-REVERSA CAM 18.5CM PARA MONI-ESPEJO



1080P HD



140°  
Grados de visión



Proyección  
imagen trasera



Monitor de parqueo



Dos entradas de video



## KTS209

ESPEJO CON MONITOR 70X50 MM PARA ASIS-PARQUEO



1080P HD



140°  
Grados de visión



Proyección  
imagen trasera



Monitor de parqueo



Dos entradas de video



## KTS280

DVR BLACKBOX CAMARA LENTE  
CENTRAL INFRARROJA X1 Pd02



## KTS258

CAMARA CON  
INFRAROJO PLACA X1



# Catálogo de **Productos Truck**



**Botiquín** 

**MENÚ** 



## KTB004 BOTIQUÍN 19 ELEMENTOS.

### Contiene:

- 2 Curas
- 1 Bisturi
- 1 Silbato
- 1 Geringa
- 1 Baja lenguas
- 1 Preservativo
- 1 Banda elástica
- 1 Toalla higiénica
- Cuello ortopédico
- 1 Apósito de gasa
- 1 Paquete de copitos
- Algodón puro 5 gramos
- Botella de agua 620 ml
- 1 Sal de rehidratación oral
- 1 Par de guantes de cirugía
- 1 Pastillas de acetaminofen







# Catálogo de **Productos Truck**

**Cinturones de  
Seguridad** 

**MENÚ** ▶



## Cinturones de Seguridad

**Producto  
Certificado**



**KTC004**

**Cinturón de  
Seguridad  
Retractor  
2 Puntos**

1 metro

15 cm

CINTURÓN DE SEGURIDAD  
FLJO 2 PUNTOS (FEA007) (KTC004)  
  
PAÍS DE ORIGEN: CHINA  
IMPORTADOR: ARANI LTDA  
LOTE N°: 0826-09-2019





# Cinturones de Seguridad

# Catálogo de Productos Truck

## Cinturones de Seguridad

**Producto  
Certificado**

CINTURÓN DE SEGURIDAD  
RETRACTOR DE 3 PUNTOS (FEA013) (KTC028)  
  
PAÍS DE ORIGEN: CHINA  
IMPORTADOR: ARANI LTDA  
LOTE N°: 0826-09-2019



**KTC028**  
Cinturón de Seguridad  
**Retractor 3 Puntos**

3.10 metros



## Guayas para Cinturones de Seguridad



Pasajero

**KTC031**

Guaya cinturón de **seguridad corto izquierdo.**



Conductor

**KTC030**

Guaya cinturón de **seguridad corto derecho.**



# Catálogo de **Productos Truck**



**Extintores y  
Soportes** 

**MENÚ** ▶



**KTF084**  
EXTINTOR 10LBS  
ABC ANILLO



**KTF088**  
EXTINTOR 20LBS  
ABC ANILLO



**KTV007**  
SOPORTE VEHI METAL  
EXTINTOR 10LBS  
10742400



**KTV053**  
SOPORTE VEHI  
METAL/HEBILLA EXT 10LBS  
10705367



Catálogo de **Productos Truck**

**Gatos Hidráulicos** 

**MENÚ** 





**KTG016**  
GATO HIDRA 6 TON  
BOTELLA 185-355mm



**KTG014**  
GATO HIDRA 4 TON  
BOTELLA 180-340mm



# Catálogo de **Productos Truck**

**Herramientas** 

**MENÚ** 

**KTT012**  
TACOS MADERA GDE CAMION  
13cm X 13cm x 25cm – X2

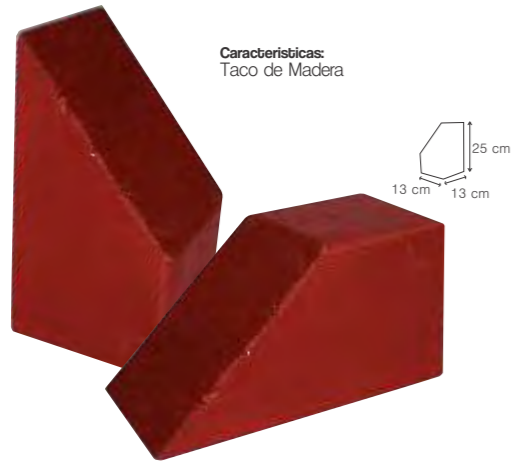

Características:  
Taco de Madera

**KTV005**  
BAYETILLA 70X40 CMS



Características:  
Tela absorvente

**KTV006**  
KIT DE 5 HERRAMIENTAS  
REGLAMENTARIAS BOLSA



Características:

Llave expansiva 6 pulgadas 15.5x4.5cm.  
Destornillador doble punta 19x2.5cm.  
Bolsa recerrable slider 14x22cm.  
Llave mixta 10 chrome 13x2.5cm.  
Llave mixta 1/2 chrome 15x3cm.  
Alicate 6 pulgadas 15.5x6cm.



**KTV250**  
CABLE INICIAR  
600 AMP IMP

Características:

Cables de caucho.  
Cuatro pinzas metálicas en cobre,  
con manijas en caucho.  
Alambre cobre.



Catálogo de **Productos Truck**

**Señales Reflectivas** 

**MENÚ** 



**KTS007**  
SEÑAL CONO REFLEC  
FLEX VC B/HEXAG  
45CM

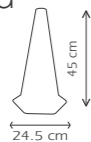

**KTS008**  
SEÑALCONOREFLEC  
FLEXPVC B/CUADR  
47CM

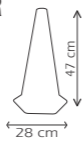

**KTS009**  
SEÑALCONO REFLECFLEX  
PVC B/HEXAG  
70CM

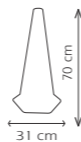

**KTS033**  
SEÑALCONOREFLEC  
FLEXPVC B/CUADR  
70CM



Señal cono reflectivo  
plegable base cuadrada



**KTS020**  
45cm



**KTS022**  
60cm



**KTS052**  
60cm X 2 Unidades.





## KTV121

CHALECO NAR REFLECTANTE  
2 BANDAS REFLECTIVAS 5CM



Estos chalecos reflectantes sirve para mejorar la seguridad del personal que transita por las vías, o de los usuarios en una situación de parada de emergencia; la persona debe ser vista por los demás usuarios de la vía.

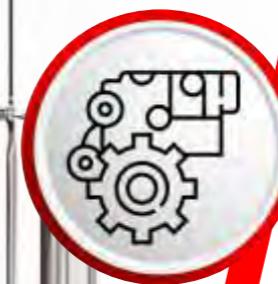

## **Espejos**

**Espejos Adhesivos**

**Espejos Auxiliares**

**Espejos Brazo**

**Espejos Principales**



Arani Ltda



Lujos Arani Ltda



[www.arani.com.co](http://www.arani.com.co)



Espejos

Producto

¡Nuevo!

ESA051

ESPEJO AUX CONVEXO 5"  
ACERO INOX TOR CENT 330-005-S

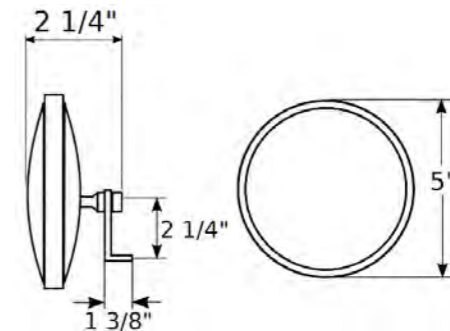

**arani**®

EL MEJOR MEDIO PARA SURTIR SU NEGOCIO



Arani Ltda



Lujos Arani Ltda



[www.arani.com.co](http://www.arani.com.co)



# Espejos

**Producto**  
**¡Nuevo!**



**ESA057**  
ESPEJO CROM CAPOT VOLVO VNM,  
VNL,VNX IZQ 330-194-L



**ESA056**  
ESPEJO CROM CAPOT VOLVO VNM,  
VNL,VNX DER 330-195-R





**ESA220**  
ESPEJO ADHE PLAST NEG AJUSTABLE 2" X1



**ESA030**  
ESPEJO ADHE PLAST CROM AJUSTABLE 3" X1

## ESPEJOS ADHESIVOS PLÁSTICOS



**ESA205**  
ESPEJO ADHE PLAST KD5150 TW 1-1/2" X1



**ESA210**  
ESPEJO ADHE PLAST KD5160 TW 2" X1



**ESA208**  
ESPEJO ADHE PLAST KD5156 TW 2-1/2" X1



**ESA212**  
ESPEJO ADHE PLAST KD5162 TW 3-1/4" X1



**ESA214**  
ESPEJO ADHE KD5163 TW 4X5 1/2" X1

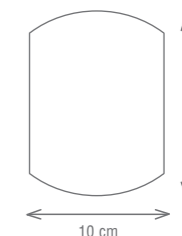

**ESA225**  
ESPEJO ADHE PLAST KD5153 TW  
CUÑA 50X28MM X1

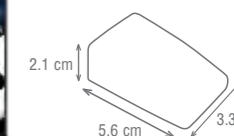

**ESA044**  
ESPEJO AUX REDONDO ACERADO  
BURBUJA KTC 8 1/2"



**ESA048**  
ESPEJO AUX REDONDO ACERADO  
OJO PESCADO KTC 8 1/2"



**ESA045**  
ESPEJO AUX RED ACERADO KTC  
7 1/2" TOR LATERAL X1



**ESA046**  
ESPEJO AUX RED ACERADO KTC  
8 1/2" TOR LATERAL X1





**ESA040**  
ESPEJO AUX REDONDO ACERADO KTC 6''

**ESA041**  
ESPEJO AUX REDONDO ACERADO KTC 7 1/2''

**ESA042**  
ESPEJO AUX REDONDO ACERADO KTC 8 1/2''



**ESL042**  
ESPEJO LATERAL AUXILIAR  
NEGRO PARA FREIGHTLINER M2 330-112A



**ESL046**  
ESPEJO LATERAL AUXILIAR  
NEGRO UNIVERSAL ISUZU FTR 220X170 X1



**ESA032**  
ESPEJO AUX LUNA CONVEXA  
BUSCA RATAS ACERO INOX IMP



**ESA030**  
ESPEJO AUX LUNA CONVEXA BUSCA RATAS IMP



**ESA028**  
ESPEJO AUX LUNA CONVEXA BUSCA RATAS NAL



**ESA043**  
ESPEJO AUX REC ACERO CONVECXO 5 7/8" X 4 3/8"





**ESA049**  
BRAZO ESPEJO ACEROINOXIDABLE  
PARA CAPOT 8 ½ X 1Und.



**ESA059**  
ESPEJO CROMADO CAPOT  
FREIGHTLINER CASCADIA DERECHO X 1Und



**ESA058**  
ESPEJO CROMADO CAPOT  
FREIGHTLINER CASCADIA IZQUIERDO X 1Und





**ESA061**  
ESPEJO CAPOT FREIGHTLINER  
CASCADIA DERECHO X1PC



**ESA060**  
ESPEJO CAPOT FREIGHTLINER  
CASCADIA IZQUIERDO X1PC

Parte de atrás  
del espejo



**ESA065**  
ESPEJO PARA CAPOT VOLVO  
VNM,VNL,VNX DERECHO X1

Parte de atrás  
del espejo



**ESA066**  
ESPEJO PARA CAPOT VOLVO  
VNM,VNL,VNX IZQUIERDO 1X



**ESE064**  
ESPEJO LATERAL MERCEDES  
NEGRO (7 7/8" X 16 7/8") x1



**ESL048**  
ESPEJO LATERAL PRINCIPAL  
NEGRO UNIVERSAL ISUZU FTR 220X385 X1



**ESL041**  
ESPEJO LATERAL PRINCIPAL  
CROMADO PARA FREIGHTLINER M2 330-120C



**ESL040**  
ESPEJO LATERAL AUXILIAR  
CROMADO PARA FREIGHTLINER M2 330-118C





## **Plumillas**

**Aerodinámicas**

**Híbridas**

**Metálicas**

**Brazos**



# Catálogo de **Productos Truck**

**Brazos** 

**MENÚ** ▶

**BRC105**  
BRAZO CODINTER CH/LET NPR TURBO X1



**BRC106**  
BRAZO CODINTER CH/LET NPR X1



**BRC253**  
BRAZO CODINTER KODIAK X1

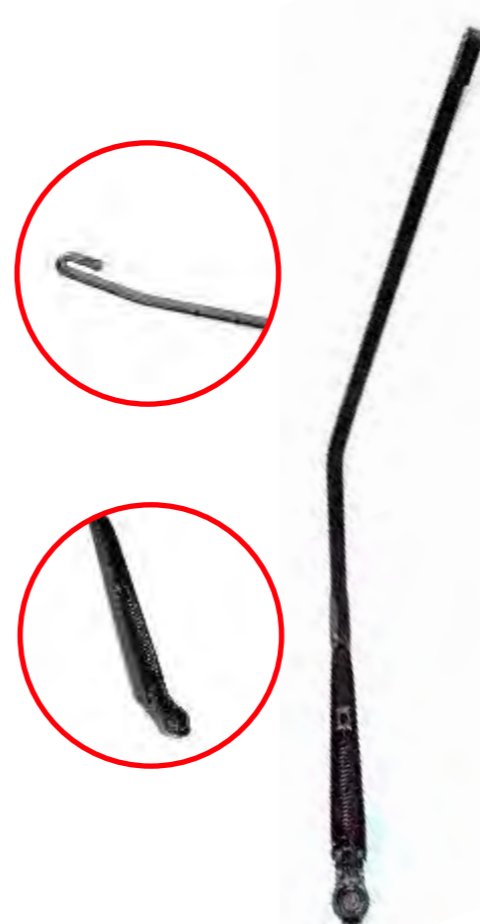



**BRC614**  
BRAZO CODINTER MICROBUS 24 DEL X1  
**BRC616**  
BRAZO CODINTER MICROBUS 26 DEL X1



**BRC714**  
BRAZO CODINTER PANTÓGRAFO 24 X1  
**BRC718**  
BRAZO CODINTER PANTÓGRAFO 28 X1  
**BRC802**  
BRAZO CODINTER PANTÓGRAFO 32 X1

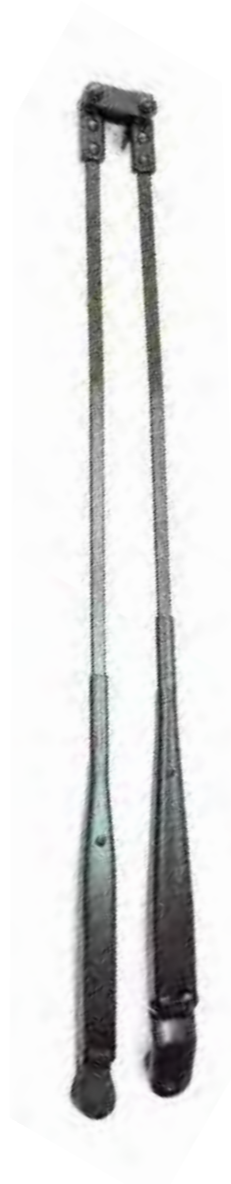

# Catálogo de **Productos Truck**

**Plumillas  
Aerodinámicas** 

**MENÚ** ▶



**Youwin**  
PLUMILLAS



Nueva  
Presentación



- PUF040**  
No.18 X1
- PUF041**  
No.20 X1
- PUF042**  
No.22 X1
- PUF043**  
No.24 X1
- PUF044**  
No.26 X1

 **BOSCH**  
AEROFIT



- PUF118**  
No. 18 X1
- PUF120**  
No. 20 X1
- PUF122**  
No. 22 X1
- PUF124**  
No. 24 X1
- PUF126**  
No. 26 X1

**Plumillas  
aerodinámicas**  
con adaptadores universales

**Aero MASTER**  
**EXTREME**  
WIPERBLADE



- PUF238**  
No. 18 X1
- PUF240**  
No. 20 X1
- PUF242**  
No. 22 X1
- PUF244**  
No. 24 X1
- PUF246**  
No. 26 X1
- PUF248**  
No. 28 X1

**HELLA**  
CLEANTECH



- PUF278**  
No. 18 X1
- PUF280**  
No. 20 X1
- PUF282**  
No. 22 X1
- PUF284**  
No. 24 X1
- PUF286**  
No. 26 X1

**Plumillas  
aerodinámicas**  
con adaptadores universales



# Catálogo de **Productos Truck**

**Plumillas  
Hidribas** 

**MENÚ** ▶

**Youwin**  
PLUMILLAS



Nueva  
Presentación



Incluye  
**9**  
Adaptadores

**PUH040**

No. 18 X1

**PUH041**

No. 20 X1

**PUH042**

No. 22 X1

**PUH043**

No. 24 X1

**PUH044**

No. 26 X1

# Plumillas híbridas

con adaptadores especiales



# Catálogo de **Productos Truck**

*Plumillas  
Métalicas* 

MENÚ ►

**Youwin**  
PLUMILLAS

Nueva  
Presentación



**PUM418**  
No. 18 X1  
**PUM420**  
No. 20 X1  
**PUM422**  
No. 22 X1  
**PUM424**  
No. 24 X1

**STAR LIGHT**



**PUM075**  
No. 18 X1  
**PUM077**  
No. 20 X1  
**PUM079**  
No. 22 X1

**EXTREME**  
WIPERBLADE



**PUM155**  
No. 18 X1  
**PUM160**  
No. 20 X1  
**PUM165**  
No. 22 X1  
**PUM166**  
No. 24 X1  
**PUM168**  
No. 26 X1  
**PUM169**  
No. 28 X1

**Plumillas  
metálicas**  
con adaptadores universales





- PUM258**  
No. 18 X1
- PUM259**  
No. 19 X1
- PUM260**  
No. 20 X1
- PUM261**  
No. 21 X1
- PUM262**  
No. 22 X1
- PUM264**  
No. 24 X1
- PUM266**  
No. 26 X1
- PUM268**  
No. 28 X1

**Titan HD**  
DURALIFE



- PUM225**  
No. 18 X1
- PUM227**  
No. 20 X1
- PUM229**  
No. 22 X1
- PUM230**  
No. 24 X1
- PUM231**  
No. 26 X1



- PUM030**  
No. 18 X1
- PUM039**  
No. 19 X1
- PUM042**  
No. 20 X1
- PUM044**  
No. 21 X1
- PUM048**  
No. 22 X1
- PUM049**  
No. 24 X1
- PUM056**  
No. 26 X1
- PUM062**  
No. 28 X1

**Plumillas metálicas**  
con adaptadores universales



- PUM318**  
No. 18 X1
- PUM319**  
No. 19 X1
- PUM320**  
No. 20 X1
- PUM321**  
No. 21 X1
- PUM322**  
No. 22 X1
- PUM324**  
No. 24 X1
- PUM326**  
No. 26 X1
- PUM328**  
No. 28 X1

**Plumillas metálicas**  
con adaptadores universales





## **Tapetes**

**CHEVROLET**

**FOTON**

**HINO**

**NISSAN**

**JAC**

**GUARDAPOLVOS**



Arani Ltda



Lujos Arani Ltda



[www.arani.com.co](http://www.arani.com.co)

# Catálogo de **Productos Truck**

**Tapetes** 

**MENÚ** 





## **Tapetes CHEVROLET**

**CHEVROLET FORWARD /FRR**

**CHEVROLET SERIE TRUCKS**

**CHEVROLET N200 / N300**

**CHEVROLET VAN**

**CHEVROLET NHR**

**CHEVROLET NKR**

**CHEVROLET NPR**

**CHEVROLET NQR**



Arani Ltda



Lujos Arani Ltda



[www.arani.com.co](http://www.arani.com.co)

**TAT125**  
TAP 1P CH/LET FTR FORWARD 196X58CM

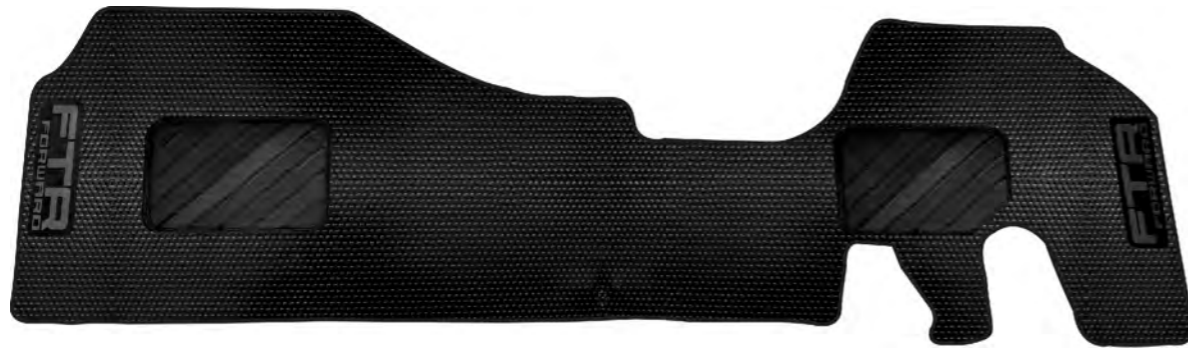
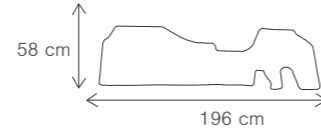

**TAT135**  
TAP 1P CH/LET FVR FORWARD 198X58CM

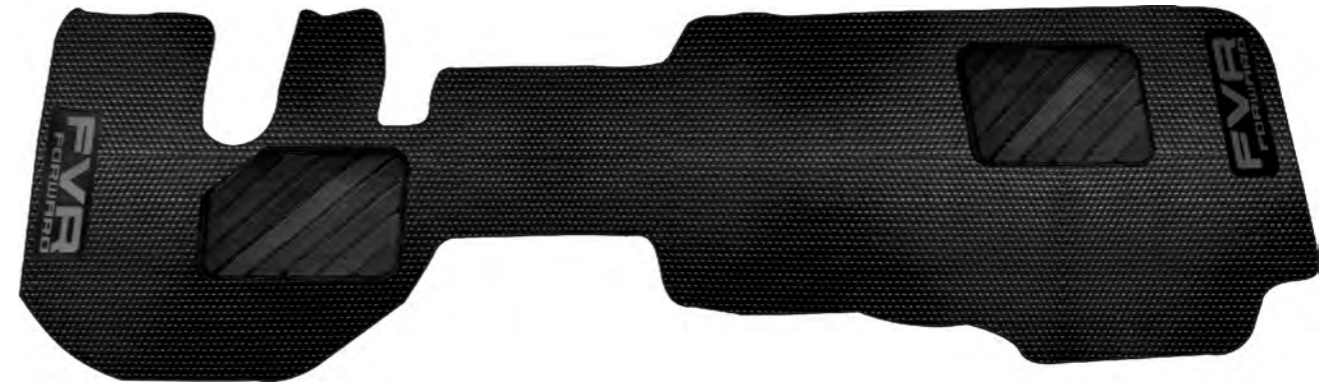
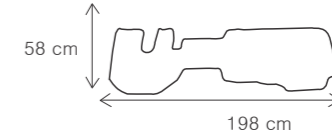

**TAT045**  
TAP CABINA CH/LET  
FRR 178 X61 CM

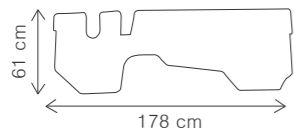

**Características:**

Tapetes en PVC. De 3mm de espesor mínimo.





**TAT155**  
TAP 1P CH/LET N300 117X80CM

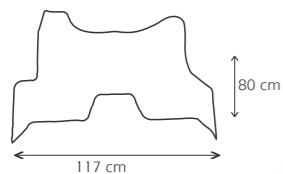

**TAT145**  
TAP 1P CH/LET N200 130X87CM

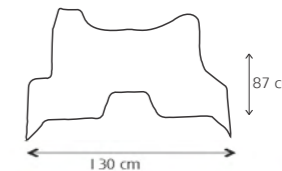

**TAT009**  
TAP CABINA  
CH/LET NHR

Características:  
Material plástico PVC.



**TAI310**  
TAP 1P SINT CORT CH/LET  
NHR 2012-2019





**TAI312**

TAP 1P SINT CORT CH/LET NKR 2012-2019



**TAT010**

TAP CABINA CH/LET NKR

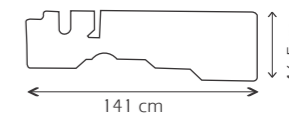

**TAT046**

TAP CABINA FTR CAMION  
50.1X172CM

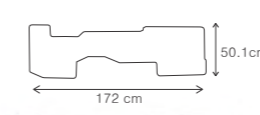

**Características:**  
Material plástico PVC.  
REF:TNKR

**Características:**  
Tapetes en PVC. De 3mm de espesor mínimo.

**Producto**  
**¡Nuevo!**



**TAV056**  
TAP 1P TACARMAX CORT  
NEG CH/LET NHR 2013-2021



**TAV052**  
TAP 1P TACARMAX CORT  
NEG CH/LET NHR 2006-2012

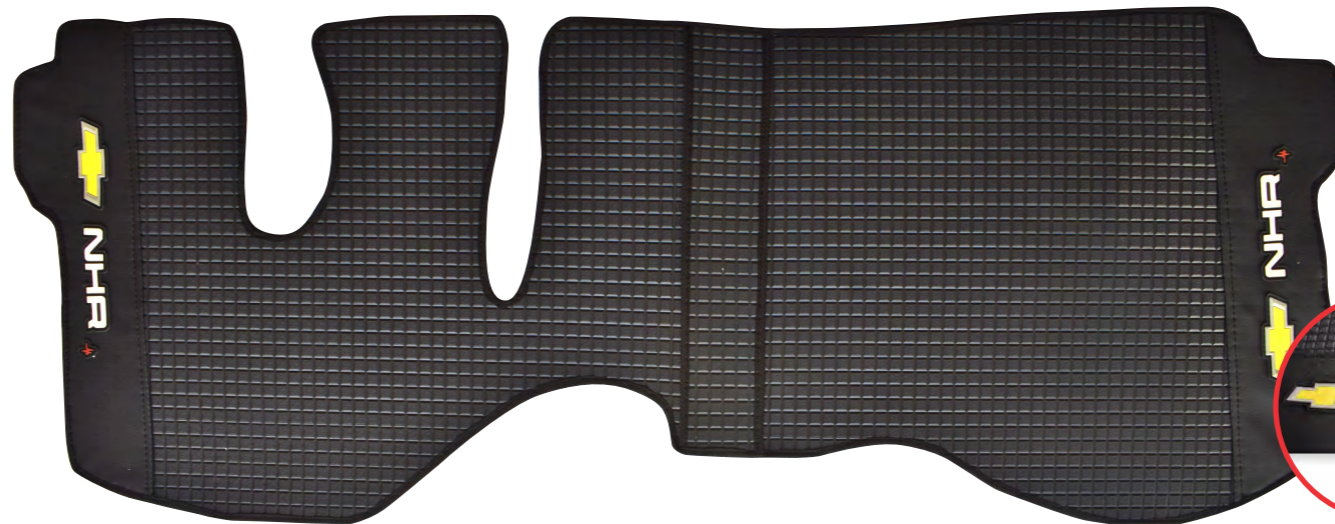



**Producto**  
**¡Nuevo!**



**TAV062**  
TAP 1P TACARMAX CORT NEG CH/LET  
NKR 2013-2021

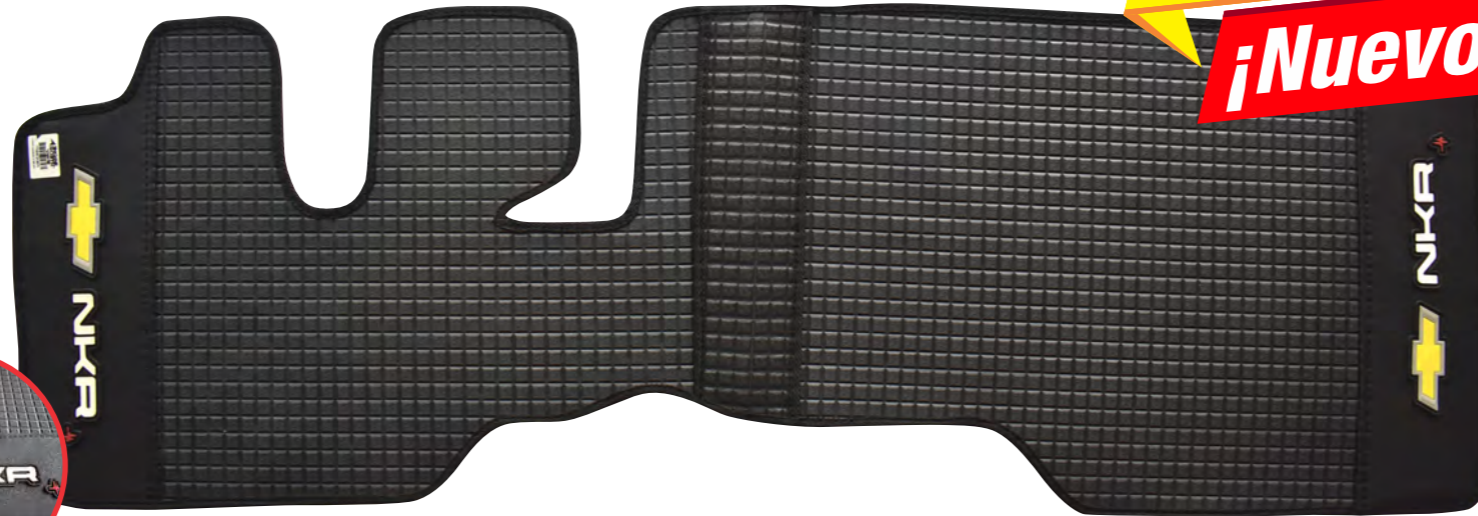

**TAV060**  
TAP 1P TACARMAX CORT  
NEG CH/LET NKR 2006-2012



**TAI316**

TAP 1P SINT CORT CH/LET NPR 2012-2019



**TAT011**

TAP CABINA CH/LET NPR

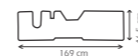

Características:  
Material plástico PVC.  
REF: TNPR

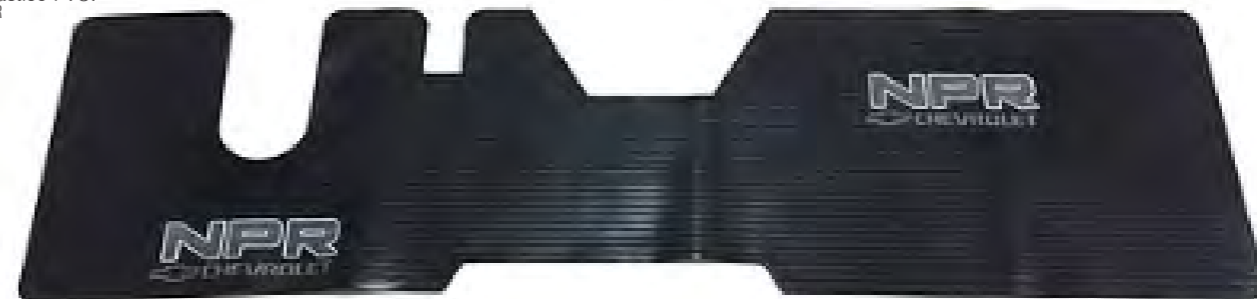

**TAT012**

TAP CABINA CH/LET TRUCK NPR

Características:  
Tapete en caucho PVC.  
Protege el piso original del vehículo.  
REF: TNPR NEW



**TAT175**

TAP 1P CH/LET NPR REWARD 169X58CM

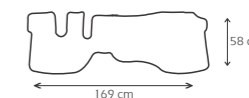



**Producto**  
**¡Nuevo!**

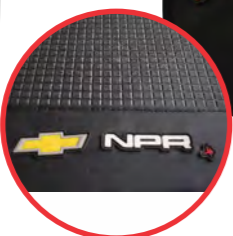

**TAV070**  
TAP 1P TACARMAX CORT NEG CH/LET  
NPR 2006-2012

**TAV072**  
TAP 1P TACARMAX CORT NEG CH/LET  
NPR 2013-2021

**Producto**  
**¡Nuevo!**



**TAT013**  
TAP CABINA CH/LET NQR 168X54CM



**Características:**  
Material plástico PVC.  
REF: NPR

**TAI314**  
TAP 1P SINT CORT CH/LET NQR 2012-2019





**TAI227**  
TAPETE 1 PIEZA  
SINTETICO AL CORTE  
CHEVROLET VAN N300 2017



**TAT160**  
TAP 1P CH/LET SERIE N TRUCKS 141X49CM

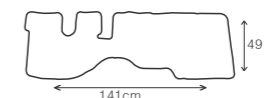



## **Tapetes FOTON**

**FOTON OIL**



**TAT017**  
TAP CABINA FOTON 2.8 TON 132X42CM

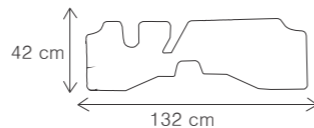

Características:  
Material plástico PVC.

**TAT016**  
TAP CABINA FOTON OLIN 4.5 TON 170 x55CM



Características:  
Material plástico PVC. REF: FOTON OLIN 4.5

**TAT015**  
TAP CABINA FOTON 3.5 TON 150X46.5 CM

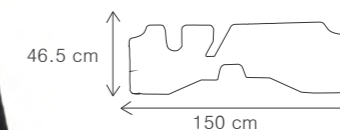

Características:  
Material plástico PVC. REF: FOTON OLIN 3.5

**TAI326**

TAP 1P SINT CORT FOTON OLIN 1069 2009



**TAI328**

TAP 1P SINT CORT FOTON OLIN 1069 2009







## **Tapetes HINO**

**HINO DUTRO / FD**



Arani Ltda



Lujos Arani Ltda



[www.arani.com.co](http://www.arani.com.co)

**TAT050**

TAP CABINA HINO DUTRO 170X51CM

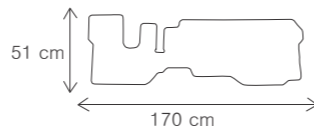

**Características:**

Tapetes en PVC. De 3mm de espesor mínimo / REF:T HINO-D

**TAI336**

TAP 1P SINT CORT HINO DTRO 300 HYBR 5.0T 2013



**TAI338**

TAP 1P SINT CORT HINO DTRO PACK 300 3.3T 2013



**TAT195**

TAP 1P HINO FG/FD/FI 180X84CM

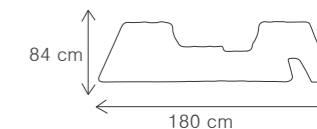





## **Tapetes JAC**

**JAC 1035 / 1061 / 1063**



Arani Ltda



Lujos Arani Ltda



[www.arani.com.co](http://www.arani.com.co)

## TAT006

TAP CABINA JAC 1061 4.5 TON

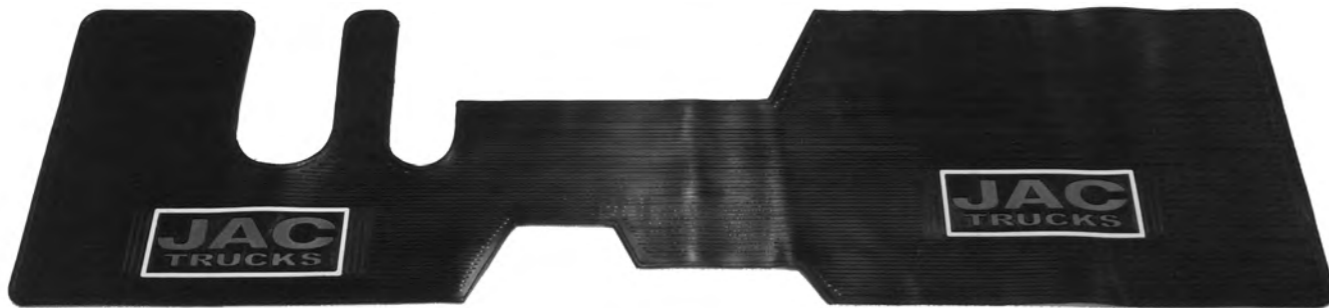

Características:  
Material plástico PVC.  
REF: TJAC

## TAI342

TAP 1P SINT CORT JAC 1035 2T 2013



## TAI344

TAP 1P SINT CORT JAC 1063 5T 2013







## **Tapetes NISSAN**

**NISSAN URVAN**



Arani Ltda



Lujos Arani Ltda



[www.arani.com.co](http://www.arani.com.co)

**TAT215**  
TAP 1P NISSAN URVAN 140X55CM

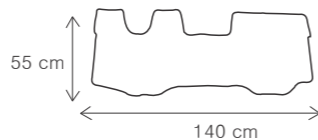



# Catálogo de **Productos Truck**

**Guardapolvos** 

**MENÚ** 

**GUT025**  
GUARDAPOLVO GRANDE NEGRO  
X 2 und.

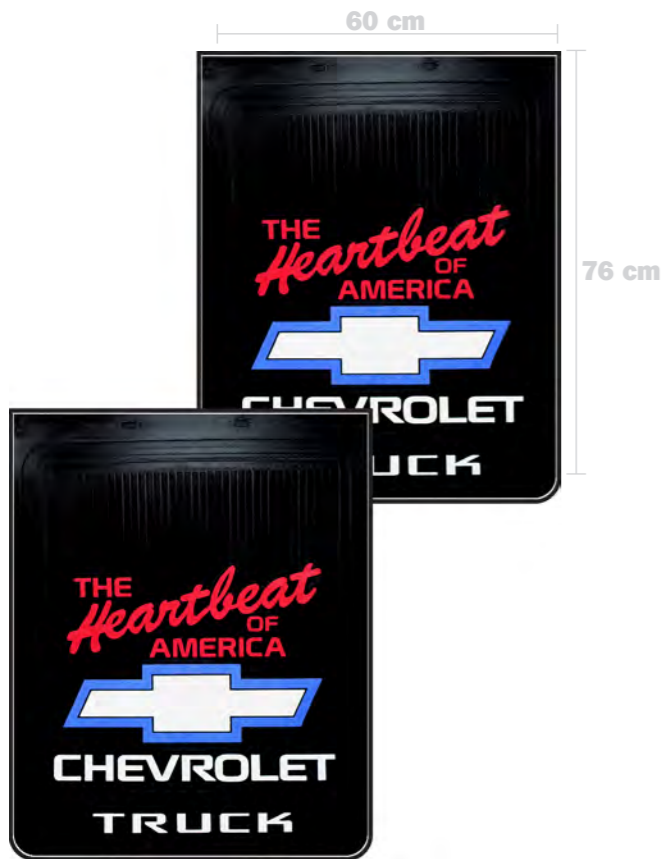

**GUP025**  
GUARDAPOLVO PEQUEÑO NEGRO  
X 2 und.



**GUN003**  
GUARDAPOLVO Gm17 Negro  
X 2 und.



**GUN019**  
GUARDAPOLVO Gp17 NEGRO  
X 2 und.





**GUT026**  
GUARDAPOLVO GRANDE NEGRO  
X 2 und.



**GUP026**  
GUARDAPOLVO PEQUEÑO NEGRO  
X 2 und.



**GUT027**  
GUARDAPOLVO GRANDE NEGRO  
X 2 und.



**GUP027**  
GUARDAPOLVO PEQUEÑO NEGRO  
X 2 und.



**GUP030**  
GUARDAPOLVO PEQUEÑO AZUL  
X 2 und.



**GUT031**  
GUARDAPOLVO GRANDE NEGRO  
X 2 und.



**GUP031**  
GUARDAPOLVO PEQUEÑO NEGRO  
X 2 und.



**GUT067**  
GUARDAPOLVO GRANDE AZUL  
X 2 und.





**GUP060**  
GUARDAPOLVO PEQUEÑO AZUL  
X 2 und



**GUT063**  
GUARDAPOLVO GRANDE ROJO  
X 2 und.



**GUP063**  
GUARDAPOLVO PEQUEÑO NEGRO  
X 2 und.



**GUT034**  
GUARDAPOLVO GRANDE NEGRO  
X 2 und.



**GUP034**  
GUARDAPOLVO PEQUEÑO NEGRO  
X 2 und.



**GUT060**  
GUARDAPOLVO GRANDE AZUL  
X 2 und.



**GUP067**  
GUARDAPOLVO PEQUEÑO AZUL  
X 2 und.



**GUT070**  
GUARDAPOLVO GRANDE ROJO  
X 2 und.





**GUP070**  
GUARDAPOLVO PEQUEÑO ROJO  
X 2 und.



**GUT033**  
GUARDAPOLVO GRANDE NEGRO  
X 2 und.



**GUT032**  
GUARDAPOLVO GRANDE NEGRO  
X 2 und.



**GUP032**  
GUARDAPOLVO PEQUEÑO NEGRO  
X 2 und.



**GUT035**  
GUARDAPOLVO GRANDE NEGRO  
X 2 und.



**GUP035**  
GUARDAPOLVO PEQUEÑO NEGRO  
X 2 und.



**GUT044**  
GUARDAPOLVO GRANDE NEGRO  
X 2 und.



**GUP044**  
GUARDAPOLVO PEQUEÑO NEGRO  
X 2 und.





**GUT036**  
GUARDAPOLVO GRANDE NEGRO  
X 2 und.



**GUP036**  
GUARDAPOLVO PEQUEÑO NEGRO  
X 2 und.



**GUT037**  
GUARDAPOLVO GRANDE NEGRO  
X 2 und.



**GUP037**  
GUARDAPOLVO PEQUEÑO NEGRO  
X 2 und.



**GUT043**  
GUARDAPOLVO GRANDE NEGRO  
X 2 und.



**GUT021**  
GUARDAPOLVO GRANDE NEGRO  
X 2 und.



**GUPO21**  
GUARDAPOLVO PEQUEÑO NEGRO  
X 2 und.





**GUT040**  
GUARDAPOLVO GRANDE NEGRO  
X 2 und.



**GUP040**  
GUARDAPOLVO PEQUEÑO NEGRO  
X 2 und.



**GUT042**  
GUARDAPOLVO GRANDE NEGRO  
X 2 und.



**GUP042**  
GUARDAPOLVO PEQUEÑO NEGRO  
X 2 und.



**GUT024**  
GUARDAPOLVO GRANDE NEGRO  
X 2 und.



**GUP024**  
GUARDAPOLVO PEQUEÑO NEGRO  
X 2 und.



**GUT041**  
GUARDAPOLVO GRANDE NEGRO  
X 2 und.



**GUP041**  
GUARDAPOLVO PEQUEÑO NEGRO  
X 2 und.





**GUT028**  
GUARDAPOLVO GRANDE NEGRO  
X 2 und.



**GUT029**  
GUARDAPOLVO PEQUEÑO NEGRO  
X 2 und.





## **Papel y cintas**

**Cintas Adhevisas**

**Conspicuity**

**Película de Seguridad**

**Papel Polarizado**





Cinta doble faz

**3M**  
Ciencia  
Aplicada a la vida™

**CIS008**  
CINTA 3M DOBLE FAZ **12MMX5MTS X1**

**CIS010**  
CINTA 3M DOBLE FAZ **18MMX5MTS X1**



Cinta doble faz

**KTC**®  
GROUP

**CIS016**  
CINTA KTC DOBLE FAZ 1/2 **12MMX5MTS X1**

**CIS018**  
CINTA KTC DOBLE FAZ 1/2 **12MMX30MTS X1**

**CIS017**  
CINTA KTC DOBLE FAZ 3/4 **18MMX5MTS X1**

**CIS019**  
CINTA KTC DOBLE FAZ 3/4 **18MMX30MTS X1**

Cinta aislante



**CIS020**  
CINTA KTC AISLANTE 18MMX9MTS X10

**CIS015**  
CINTA KTC AISLANTE 18MMX18MTS X10



# Conspicuity

# Catálogo de Productos Truck



## 3M

Vehículo Carga pesada



## 3M

Vehículo de Pasajeros



## 3M

Maquinaria Agrícola,  
Industrial y construcción



## Cinta conspicuity original 3M

### CUMPLIMIENTO NORMATIVO

- Cumple **Resolución 1572** del 3 de Mayo de 2019.
- Cumple y supera **Norma NTC 5807 -DOT C2** (ASTM D4956 tipo V).
- Manual de señalización 2015 para vehículos de obra ligeros o pesados.
- Cumple el Reglamento Técnico 538 del Ministerio de Industria y Comercio.

### FÁCIL Y RÁPIDA APLICACIÓN

- Instalación sobre superficies **lisas y metálicas**.
- Adhesivo **sensible** a la presión.
- **Protector** del adhesivo fácil de remover.
- Tiras pre - cortadas, o cortadas en rollo.

### CALIDAD DEL PRODUCTO

- Fabricación en policarbonato que evita la oxidación y el cambio de color.
- Resistente a lavado a **alta presión** (1250 PSI).
- Resistente a químicos (gasolina, diésel, kerosene, xilenos entre otros).
- **Alta angularidad** permite mejor visibilidad.



## Cinta original **3M** para marcación vehicular.

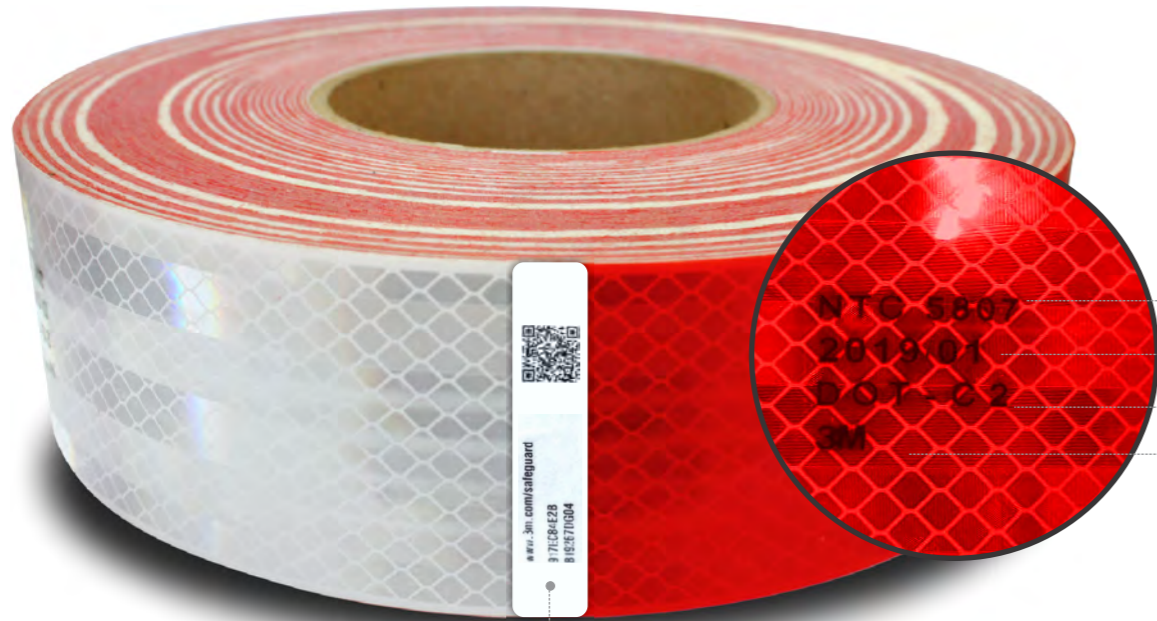

### PAM100

Cinta Conspicuity 3m original BLANCO-ROJO 5cmx45.7m

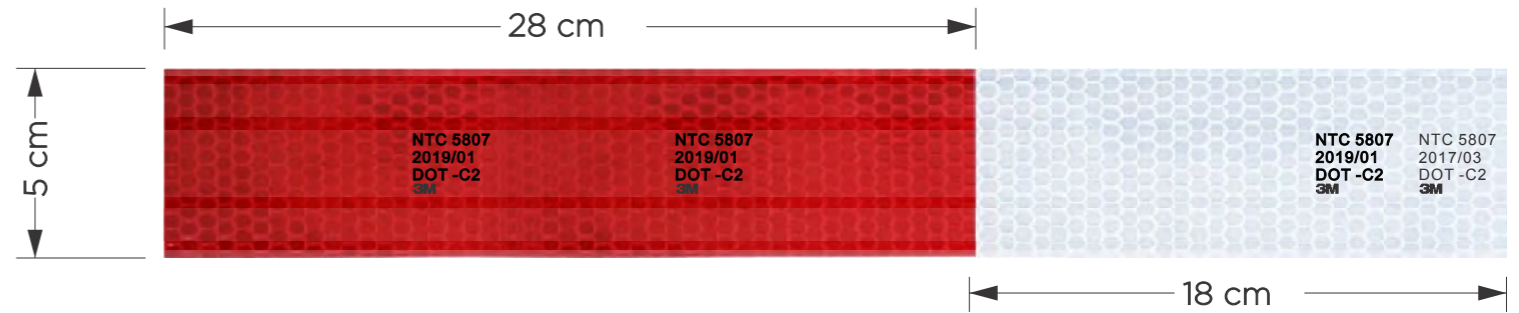

- Norma Técnica
- Año y Mes de Fabricación F-F.
- Certificación.
- Logo o marca del fabricante.

Verifique si es original con el sticker de seguridad  
(Se puede verificar hasta 3 veces).

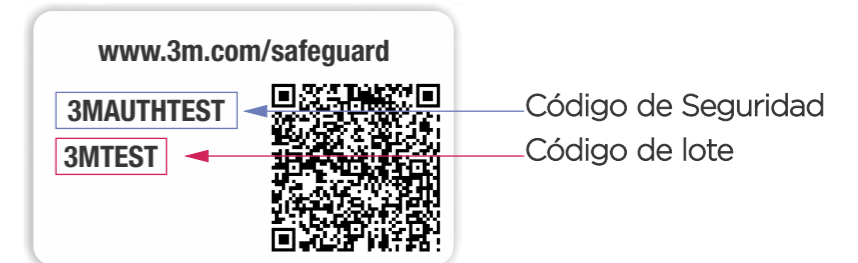

## PAM112

Cinta Conspicuity 3M Original Rojo 5 cm x 45.7 m

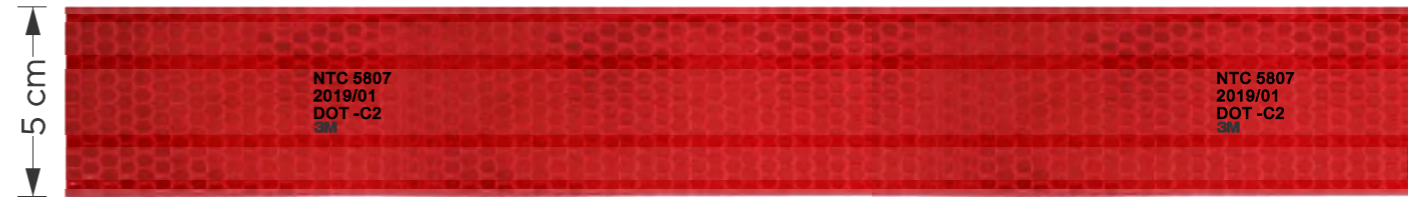

Norma Técnica  
Año y Mes de Fabricación F-F.  
Certificación.  
Logo o marca del fabricante.

- Verifique si es original con el sticker de seguridad (Se puede verificar hasta 3 veces).
- Marcación del rollo interna

Cinta original **3M**  
para marcación vehicular.



## PAM113

Cinta Conspicuity 3M Original Blanco 5 cm x 45.7 m

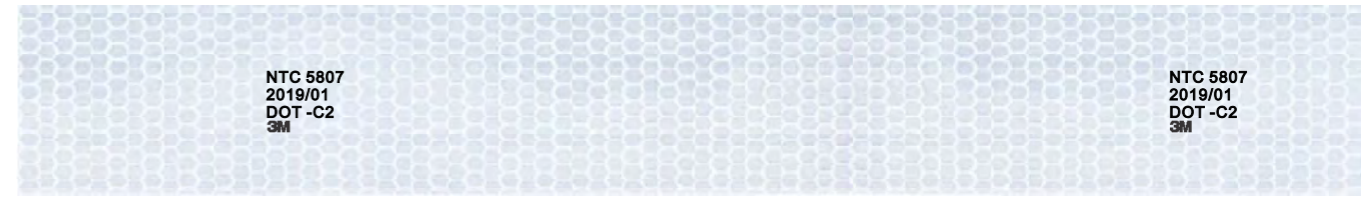
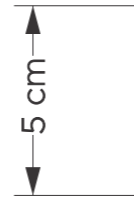

[www.3m.com/safeguard](http://www.3m.com/safeguard)

3MAUTHTEST

3MTEST

Código de Seguridad

Código de lote

Verifique si es original con el sticker de seguridad (Se puede verificar hasta 3 veces).

Norma Técnica  
Año y Mes de Fabricación F-F

Certificación.  
Logo o marca del fabricante.

Cinta original **3M**  
para marcación vehicular.



## PAM110

Cinta Conspicuity 3m Amarillo Limón Diamante 5 cm x 45.7 m

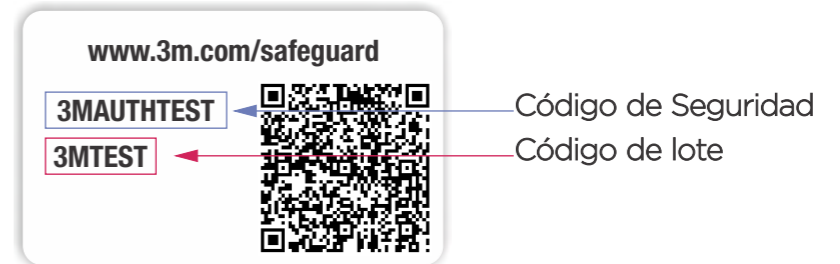
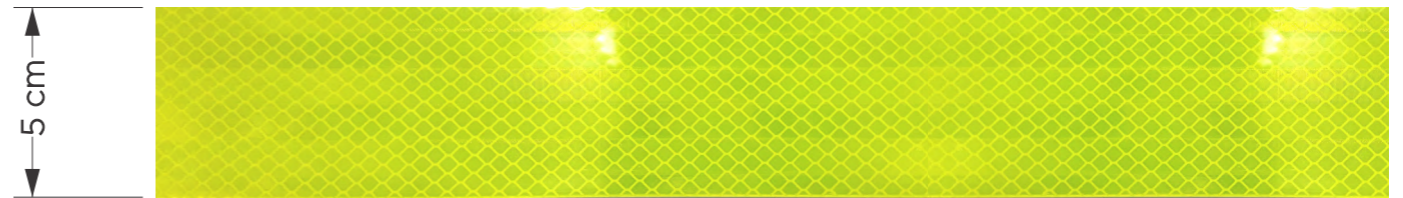

Verifique si es original con el sticker de seguridad  
(Se puede verificar hasta 3 veces).

Cinta original **3M**  
para marcación vehicular.



## PAM120

Cinta conspicuity 3M Ama 10 cm x 45.7 m

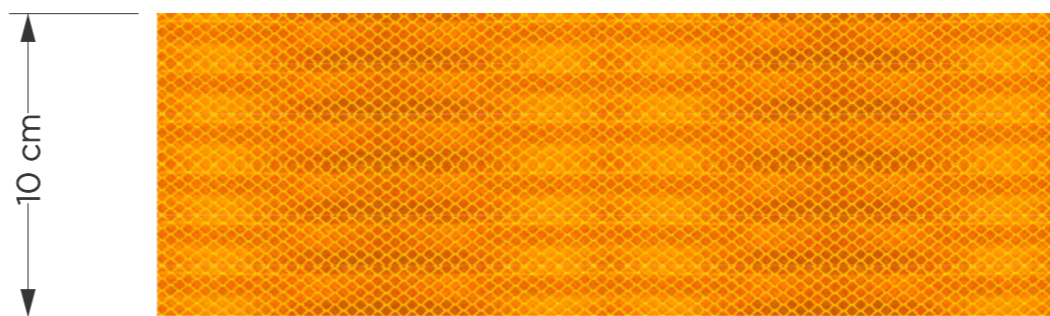

Cinta original **3M**  
para marcación vehicular.

## Validé la autenticidad de los materiales reflectantes (Conspicuity) 3M:

- 1 Encuentre los códigos.** En la etiqueta que se encuentra donde empieza el rollo, verá un código de seguridad de 10 dígitos, un código de lote de 6 dígitos y un código QR.
- 2 Ingrese los códigos.** Escanee el código QR con una aplicación para leer o escanear códigos QR o vaya a [3M.com/SafeGuard](http://3M.com/SafeGuard) e ingrese ambos códigos. Una marca de verificación verde significa que el producto es genuino. Un símbolo amarillo o rojo indica que el producto podría ser falsificado.
- 3 Marque el rollo como válido.** Haga saber a sus empleados que tiene un producto 3M genuino indicando la fecha e iniciales en la etiqueta.

**Nota:** No acepte ningún producto que ya esté marcado como válido, dado que puede ser un producto falsificado.

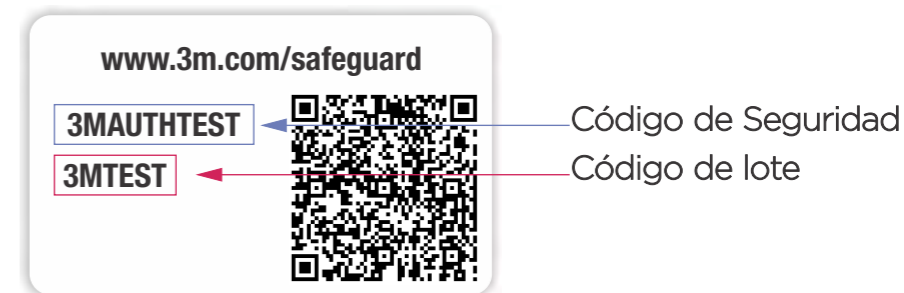

Cinta original **3M**  
para marcación vehicular.



# Catálogo de **Productos Truck**

**Papel polarizado  
y películas seguridad** 

**MENÚ** 



## 3M Película para Ventanas Automotrices Scotchshield® Serie de Seguridad

### Aumente su privacidad y seguridad

Aumente su privacidad y la de sus objetos de valor gracias a la Serie de Seguridad Scotchshield<sup>fi</sup> disponible en niveles de tinte que bloquean el ingreso de hasta el 95 % de la luz visible.



### Mejore su seguridad

Como ayuda a mantener los fragmentos de vidrio en su lugar cuando este se rompe, la Serie de Seguridad Scotchshield<sup>fi</sup> brinda una protección adicional para las personas y las propiedades, así que entrar a su vehículo les tomará más tiempo y esfuerzo de los ladrones.



### Manténgase fresco

La Serie de Seguridad Scotchshield<sup>fi</sup> ofrece protección contra los rayos ultravioletas (UV) del sol, ya que rechaza hasta el 41 % de la energía total del sol que atraviesa sus ventanas.

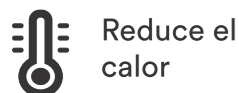

### Manténgase conectado

La Serie de Seguridad Scotchshield<sup>fi</sup> es una película no metalizada que no interfiere con dispositivos móviles, GPS ni con la recepción de radio satelital.

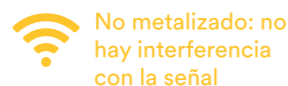

### Protección superior contra rayos UV

La Serie de Seguridad Scotchshield<sup>fi</sup> bloquea hasta el 99 % de los rayos UV y proporciona un Factor de Protección Solar (FPS) total de hasta 1000. Esto les brinda a los pasajeros del vehículo protección significativa de los daños que provocan los rayos UV del sol.



### Reduce el resplandor

La Serie de Seguridad Scotchshield<sup>fi</sup> reduce notablemente el resplandor de la luz solar, lo que le permite ver mejor y concentrarse más mientras conduce.



### Garantía limitada de por vida

La Serie de Seguridad Scotchshield<sup>fi</sup> cuenta con el respaldo de una garantía limitada de por vida, una de las garantías más completas que puede obtener. Vendidas e instaladas por Instaladores Autorizados de 3M<sup>fi</sup>, nuestras películas son resistentes y están diseñadas para durar casi sin mantenimiento.



La Fundación de Cáncer de Piel recomienda usar la película para ventanas automotrices y edificios comerciales y residenciales debido a sus propiedades de filtrar los rayos UV





## Película para Ventanas Automotrices Scotchshield

### ► Serie de Seguridad

### Elija su nivel de protección

La Serie FX ST está disponible en una variedad de tonalidades para satisfacer sus necesidades.

	SAS5	SAS20	SAS35	SAS50	SASC
<b>TSER</b>					
Energía solar total rechazada	41 %	39 %	36 %	30 %	19 %
Transmisión de luz visible	6%	20%	32%	49%	88%
Rechazo de UV	99 %	98 %	99 %	97 %	96 %
Reducción del resplandor	94 %	80 %	67 %	50 %	N/C
Espesor (mils)	4	4	4	4	4



Producto	Sustrato de vidrio	Tipo de prueba	Energía de impacto (J)
3M <sup>fi</sup> Scotchshield <sup>fi</sup> Película de Seguridad (4 mil)	Vidrio templado de 4,8 mm (3/16 in)	Alto impacto (1 impacto)	88 J
		Alto impacto (1 impacto) (después de golpe central)	27 J
		Impacto múltiple (5 impactos)	17 J

## SCOTCHSHIELD

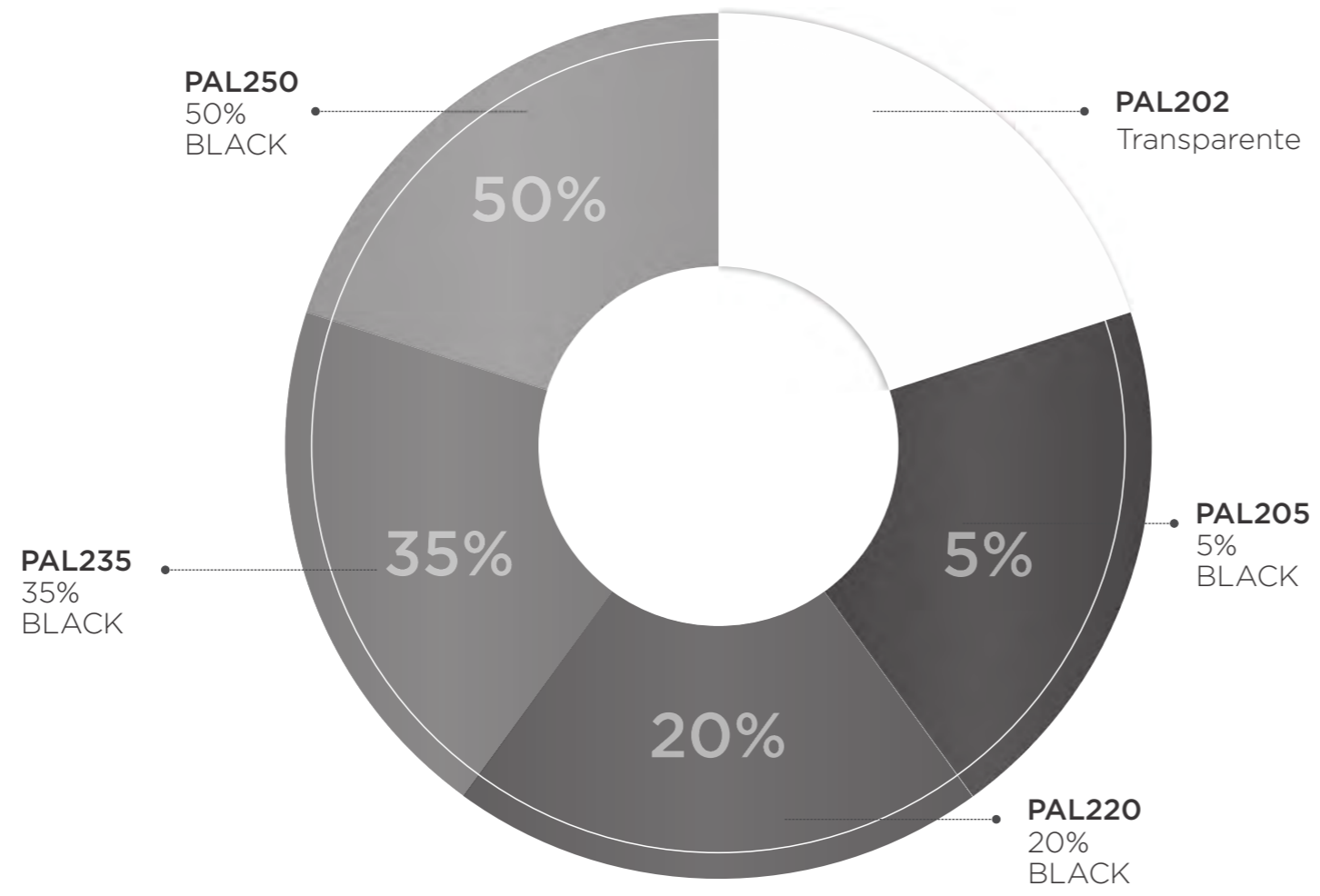

Película contramarcada cada 50cm





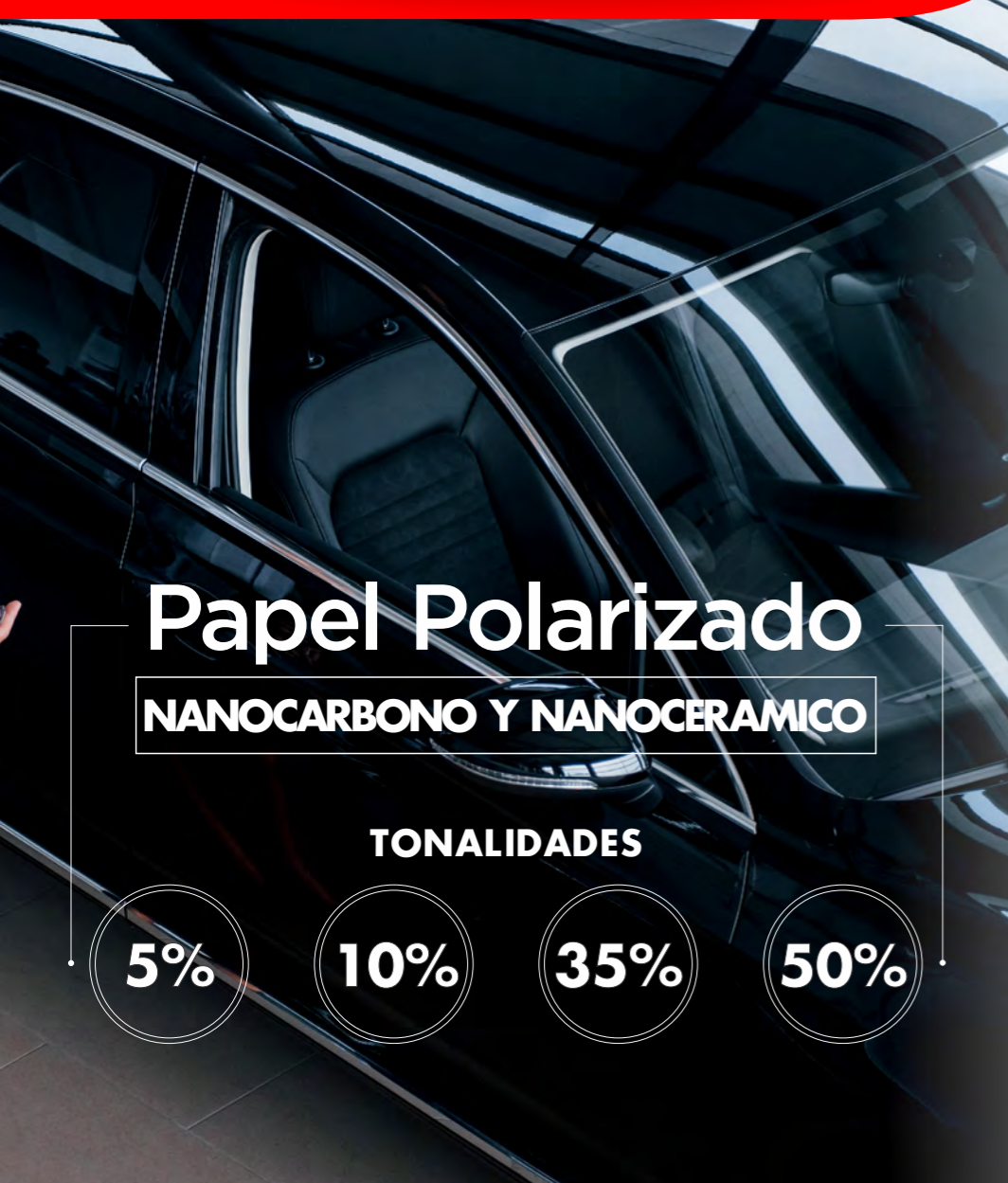

## MaxSecurity



Elimina el daño causado por los **rayos UV**.



Los vidrios polarizados **no permiten ver hacia dentro**, pero **si se puede ver de dentro hacia afuera**.



Reduce el factor de calor en el **interior del vehículo**.



Proteger los materiales dentro del vehículo y así evitar **la decoloración, desgaste y corrosión**.

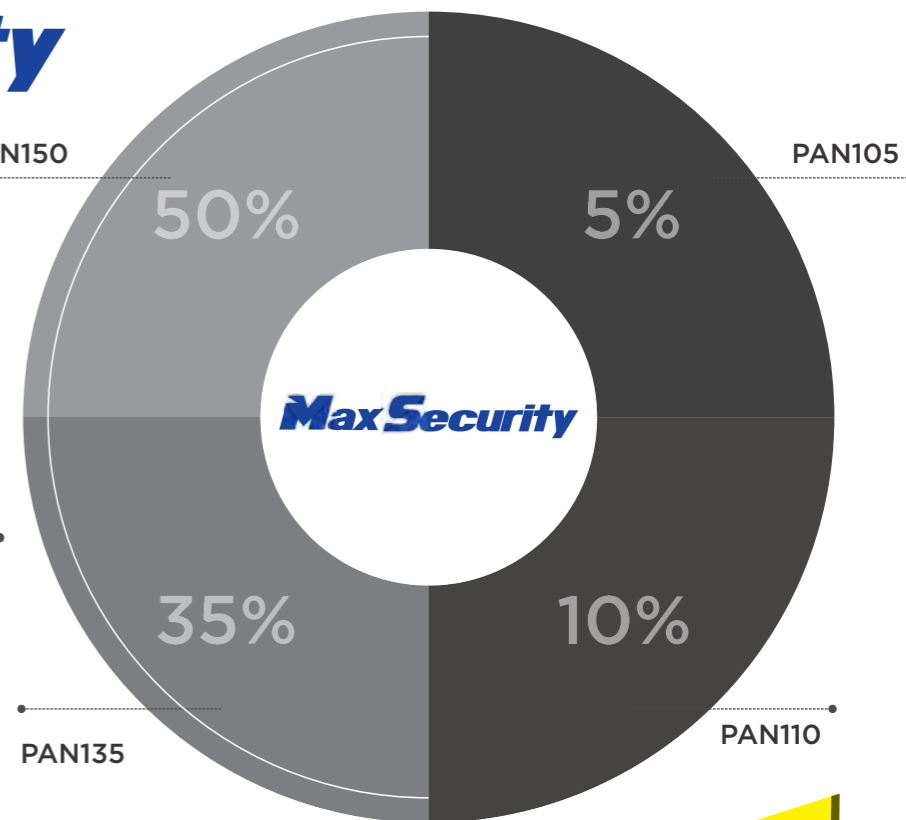

## Papel Polarizado

NANOCARBONO Y NANOCERAMICO

### TONALIDADES

5%

10%

35%

50%

**Producto**  
**¡Nuevo!**

## 3M Película para Ventanas Automotrices Serie Color Stable

### Puede relajarse

La Serie Color Stable hace que su auto luzca bien desde el exterior, mientras usted se siente bien en el interior. Rechaza hasta el 57 % de la energía solar total que pasa por las ventanas y lo protege del calor y de los rayos ultravioletas (UV) del sol.



Reduce el calor

### Aumenta la privacidad

Aumente su privacidad y la de sus objetos de valor gracias a la Serie Color Stable, disponible en niveles de tonalizado que bloquean el ingreso de la luz visible hasta el 95 %.



Aumenta la privacidad y la seguridad

### Reduce el resplandor

La Serie Color Stable reduce significativamente el resplandor del sol, lo que mejora la visibilidad y la concentración mientras conduce.



Reduce el resplandor

### Protección superior contra rayos UV

La Serie Color Stable bloquea el 99 % de la luz UV y proporciona un Factor de Protección Solar (FPS) total de hasta 1000. Esto ayuda a brindar a los pasajeros del vehículo protección significativa de los nocivos rayos UV del sol.



Bloquea hasta un 99 % de los rayos UV

### Garantía limitada de por vida

La Serie Color Stable cuenta con el respaldo de una garantía limitada de por vida, una de las garantías más completas que puede obtener. Vendidas e instaladas por 3M Instaladores Autorizados, nuestras películas son resistentes, están diseñadas para durar y son prácticamente libres de mantenimiento.



Garantía limitada de por vida



Nunca se torna púrpura



### Manténgase conectado

La Serie Color Stable es una película para ventanas no metalizada que no interfiere con dispositivos móviles, GPS ni con la recepción de radio satelital.



No metalizado: no hay interferencia



La Fundación de Cáncer de Piel recomienda usar la película para ventanas automotrices y edificios comerciales y residenciales debido a sus propiedades de filtrar los rayos UV





## Película para Ventanas Automotrices Serie Color Stable

### Elija su nivel de protección

La Serie FX ST está disponible en una variedad de tonalidades para satisfacer sus necesidades.

	CS5	CS20	CS35	CS50
<b>TSER</b>				
Energía solar total rechazada	57 %	51 %	40 %	35 %
Rechazo de rayos UV	99 %	99 %	99 %	99 %
Reducción del resplandor	90 %	79 %	56 %	42 %



## Color Stable

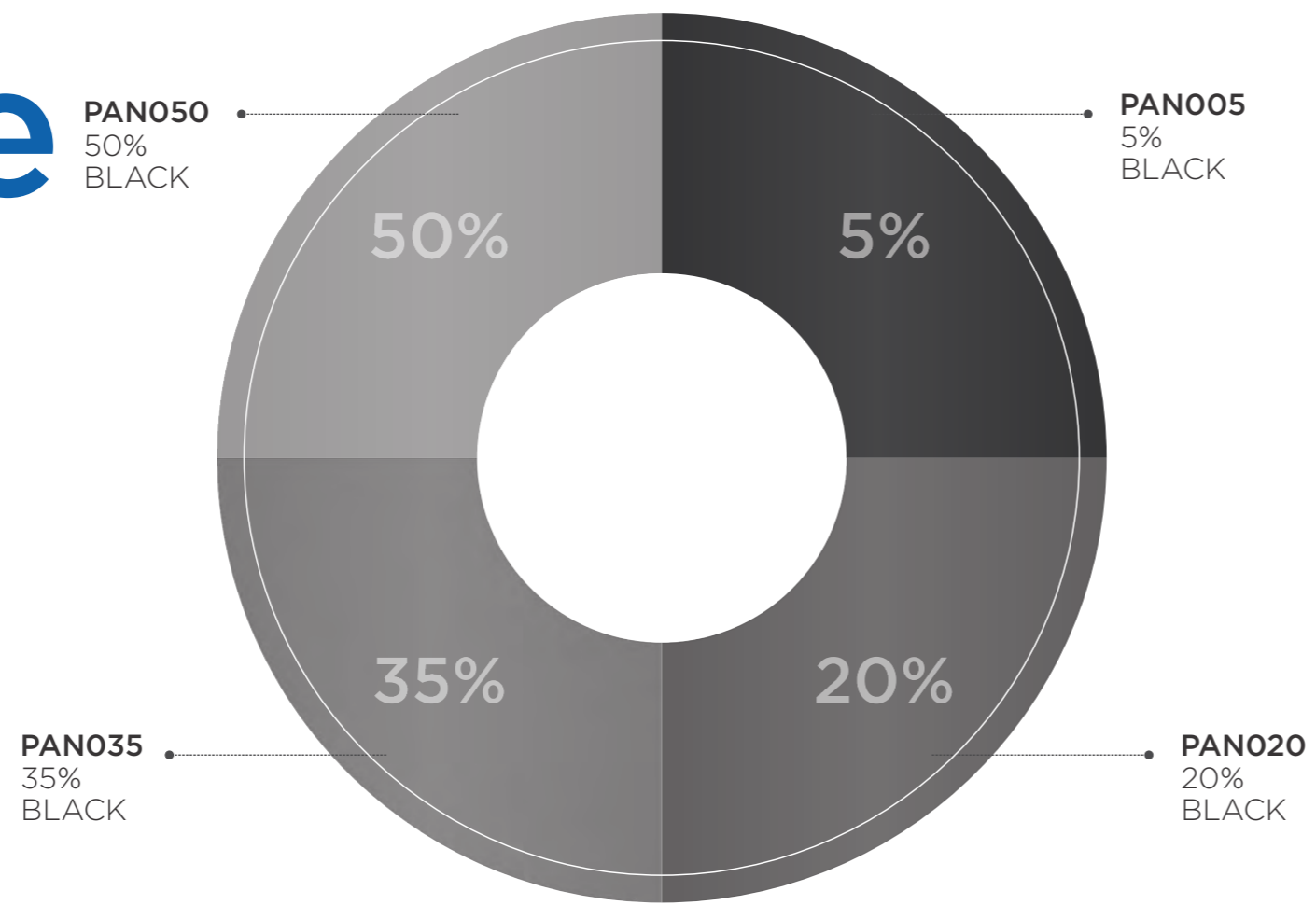

Película contramarcada cada 50cm





## 3M Película para Ventanas Automotrices Serie FX ST

### Manténgase fresco

La Serie FX ST ofrece protección contra el calor y los rayos ultravioletas (UV) del sol. Rechaza hasta el 46 % de la energía solar total que atraviesa sus ventanas para mantenerlo cómodo detrás del volante.

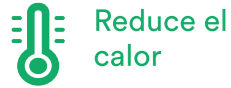

### Manténgase conectado

La Serie FX ST es una película no metalizada que no interfiere con dispositivos móviles, GPS ni con la recepción de radio satelital.

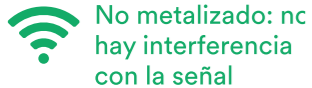

### Protección superior contra rayos UV

La serie FX ST bloquea el 99 % de los rayos UV y proporciona un Factor de Protección Solar (FPS) total de hasta 1000. Esto les brinda a los pasajeros del vehículo protección significativa de los daños que provocan los rayos UV del sol.

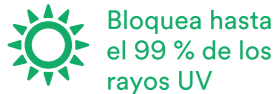

### Aumenta la privacidad

Aumente su privacidad y la de sus objetos de valor gracias a la Serie FX ST, disponible en niveles de tinte que bloquean el ingreso de hasta el 95 % de la luz visible.

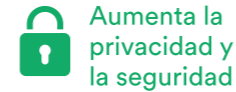

### Garantía de tres años

La Serie FX ST cuenta con el respaldo de una garantía de tres años. Vendidas e instaladas por Instaladores Autorizados de 3M<sup>®</sup>, nuestras películas son resistentes y están diseñadas para durar casi sin mantenimiento.



La Fundación de Cáncer de Piel recomienda usar la película para ventanas automotrices y edificios comerciales y residenciales debido a sus propiedades de filtrar los rayos UV



### Reduce el resplandor

La Serie FX ST reduce notablemente el encandilamiento que produce el resplandor de la luz solar, lo que le permite ver mejor y concentrarse más mientras conduce.





## Película para Ventanas Automotrices Serie FX ST

### Elija su nivel de protección

La Serie FX ST está disponible en una variedad de tonalidades para satisfacer sus necesidades.

	FX-ST 5	FX-ST 20	FX-ST 35	FX-ST 50
TSER				
Energía solar total rechazada	46 %	40 %	37 %	31 %
Rechazo de UV	99 %	99 %	99 %	99 %
Reducción del resplandor	95 %	74 %	63 %	39 %





## FX-ST

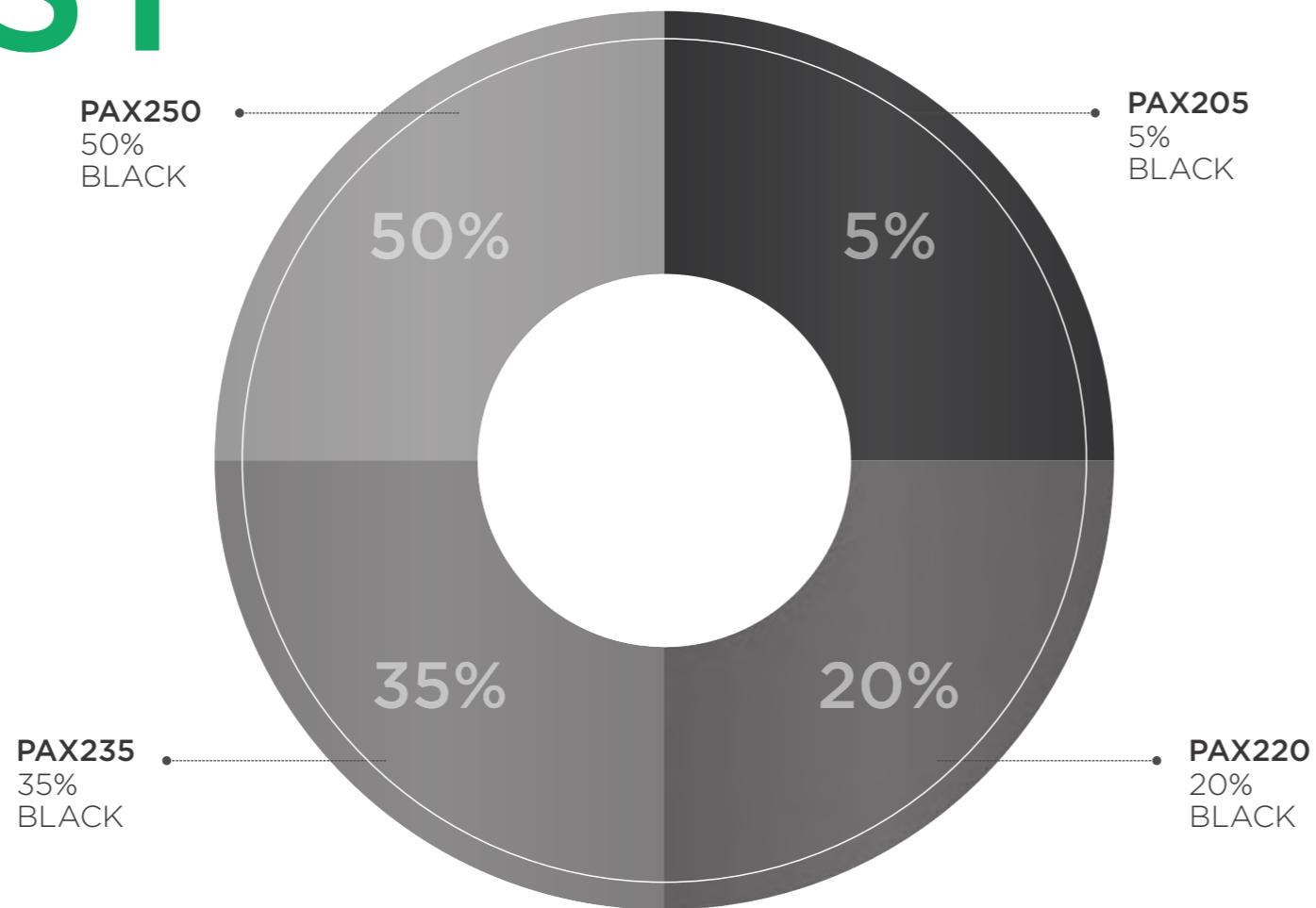

Película contramarcada cada 50cm



## Los beneficios de comprar **3M** y de ser un instalador autorizado



Cada rollo tiene **15 formatos de garantía** para efectuar esta en caso de que se presente.



Pendón publicitario y rompetráfico.



Distribuidor e instalador autorizado de la marca.

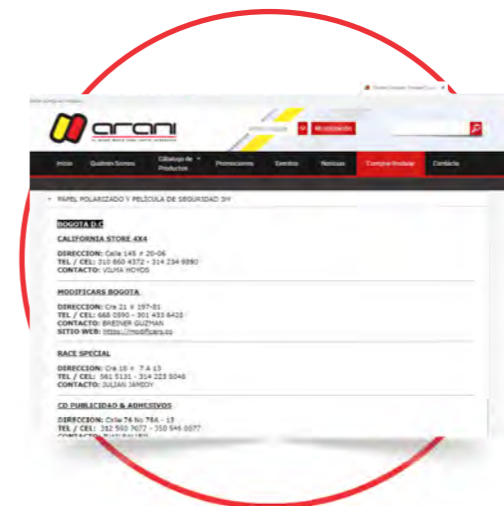

Aparecer en la página de Arani como distribuidor autorizado.



Capacitaciones **GRATIS** realizadas por **3M**



## Dyed PAX

- 1 Protege de los efectos negativos del sol, como:
  - Protege de los rayos UV, ayudando a disminuir la generación de enfermedades.
  - Disminuye el exceso de calor.
  - Alarga la vida útil de los elementos plásticos, tela, etc.
- 2 Brinda mayor comodidad ya que reduce el resplandor es decir que reduce el brillo que es generado por las luces, o el sol al que esta expuesto.
- 3 Mejora la apariencia brindándole estilo y mejora la privacidad.
- 4 Durabilidad en la lámina ya que tiene una cubierta que resiste al rayado.
- 5 Disponible en varios colores para la satisfacción el cliente
- 6 Mayor vida útil al ser construida en dos capas diferentes (el color del pegante) no destiñe.
- 7 Liner contramarcado.



## Estructura Dyed

- Capa protectora
- Capa poliéster transparente
- Capa color adhesiva
- Recubrimiento poliéster
- Capa de adhesivo
- Liner

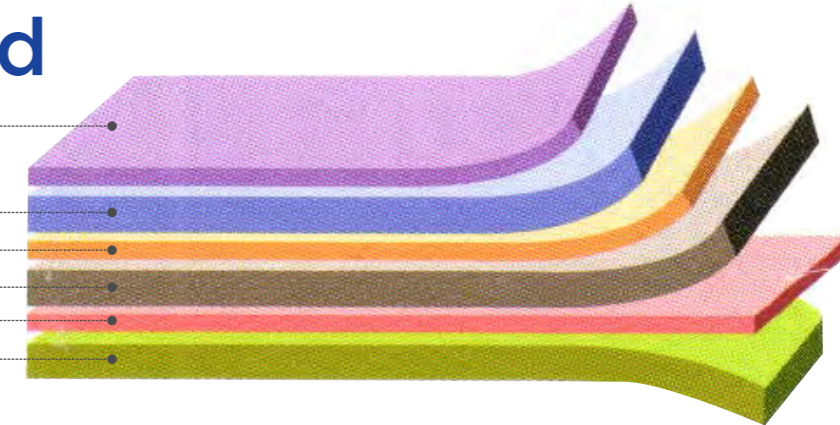

Prueba de calidad de la tinta y el pegante en un **papel polarizado**

OTRO

GLUE  
1 CAPA 20%



**Max Security**

DYED  
2 CAPAS 20%

